

# **BESSER**

## **LSC-40C** **TRANSFER CAR SYSTEM**



**MAINTENANCE/OPERATION MANUAL**  
**466367F9902**

**MAY 1999 • US\$250**

**BESSER** World Headquarters  
801 Johnson St. • Alpena, Michigan, 49707 • U.S.A.  
Phone (517) 354-4111

# **BESSER**

COMPANY NAME: .....

SERIAL NUMBER: .....

ASSEMBLY NUMBER: .....

WIRING DIAGRAM NUMBER: .....

INSTALLATION DRAWING NUMBER: .....

# LSC-40C

## TABLE OF CONTENTS

<b>LIST OF FIGURES</b> .....	.iv
<b>LIST OF TABLES</b> .....	.vi
<b>SPECIFICATIONS</b> .....	.vii
<b>ELECTRICAL DATA</b> .....	.ix
<b>SAFETY BULLETIN</b> .....	.x
<b>SAFETY SIGNS</b> .....	.xi
<b>SECTION 1 INTRODUCTION</b>	
1.1 MECHANICAL COMPONENT OVERVIEW .....	1-1
1.1.1 Racks .....	1-1
1.1.2 Rail System .....	1-3
1.1.3 Crawler .....	1-3
1.1.4 Car .....	1-3
1.1.5 Side Shifter .....	1-3
1.1.6 Rack Conveyor .....	1-3
1.2 ELECTRONIC COMPONENT OVERVIEW .....	1-3
1.2.1 Small Logic Controller/Graphic Control Station .....	1-3
1.2.2 Sensors .....	1-3
1.2.3 Actuators .....	1-3
1.3 START-UP PROCEDURE .....	1-4
1.4 SHUT-DOWN PROCEDURE .....	1-4
<b>SECTION 2 MECHANICAL OPERATION</b>	
2.1 TRANSPORT CURED RACK TO SIDE SHIFTER .....	2-1
2.2 RETRIEVE GREEN RACK FROM RACK CONVEYOR .....	2-2
2.3 TRANSPORT GREEN RACK TO KILN .....	2-3
2.4 RETRIEVE CURED RACK FROM STORAGE .....	2-4
2.5 TRANSPORT CURED RACK TO RACK CONVEYOR .....	2-5
2.6 RETRIEVE GREEN RACK FROM SIDE SHIFTER .....	2-6
2.7 TRANSPORT GREEN RACK TO KILN .....	2-7
2.8 RETRIEVE CURED RACK FROM STORAGE .....	2-8
<b>SECTION 3 CAR CONTROL SYSTEMS</b>	
3.1 CAR MANUAL CONTROLS .....	3-2
3.2 CAR GRAPHIC CONTROLS SCREEN .....	3-3

3.2.1 Main Menu Screen	3-4
3.2.2 Car Program Screen	3-5
3.2.3 Crawler Fault Diagnostic Screen	3-6
3.2.4 Rack Shuttle Main Menu Screen	3-8
3.2.5 Rack Shuttle Program Screen	3-9
3.2.6 Kiln Sequence Table Screen	3-10
3.2.7 Kiln Map Screen	3-11
3.2.8 Electrical Part Numbers Screen	3-12
3.2.9 Transfer Car Switch Locations Screen	3-13
3.2.10 Input/Output Status Screen	3-15
3.3 SENSOR TYPES	3-16
3.4 SAFETY BARS	3-16
3.5 CAR SENSORS	3-16
3.5.1 Motion Control Sensors	3-16
3.5.2 Crawler Location Sensor	3-18
3.5.3 Raillock Position	3-18
3.6 CAR INPUT/OUTPUT MODULES	3-19
<b>SECTION 4 CRAWLER CONTROL SYSTEMS</b>	
4.1 CRAWLER CONTROL STATION	4-1
4.2 SENSOR TYPES	4-2
4.3 SAFETY BARS	4-2
4.4 CRAWLER SENSORS	4-2
4.4.1 Raillock Sensors	4-4
4.4.2 Motion Control Sensors	4-4
4.4.3 Pendant Control Station Sensors	4-4
4.4.4 Elevator Position Sensors	4-4
4.4.5 Cable Reel Sensors	4-4
4.5 SIDE SHIFTER INTERFACE	4-4
4.6 CRAWLER INPUT/ OUTPUT MODULES	4-4
<b>SECTION 5 MAINTENANCE</b>	
5.1 MAINTENANCE OVERVIEW	5-1
5.2 SENSOR MAINTENANCE	5-1
5.2.1 Sensor Position	5-1
5.2.2 Sensor Cleaning	5-2
5.2.3 Enter Side Shifter Emitter	5-2
5.3 SAFETY DEVICES	5-2

5.4	HYDRAULIC SYSTEMS	5-2
5.4.1	Leakage	5-2
5.4.2	Hydraulic Fittings	5-2
5.4.3	Hydraulic Filters	5-3
5.4.4	Fluid Condition	5-4
5.5	RAILS	5-4
5.6	CABLE REEL	5-4
5.6.1	Cable Replacement for Unmounted Reel	5-7
5.6.2	Spring Replacement	5-8
5.7	LITHIUM BATTERIES	5-10
5.8	MAINTENANCE TIME TABLE	5-11
<b>SECTION 6 TROUBLESHOOTING</b>		
6.1	CAR DIAGNOSTICS	6-1
6.2	CRAWLER DIAGNOSTICS	6-1
6.3	OTHER DIAGNOSTIC CHECKS	6-2
6.3.1	Battery	6-2
6.3.2	Fuses	6-2
6.3.3	Circuit Breakers	6-3
6.3.4	Memory Loss	6-4
6.3.5	Hydraulics Failure	6-4
6.4	TECHNICAL ASSISTANCE	6-4

# LSC-40C

## LIST OF FIGURES

### SECTION 1 INTRODUCTION

1.1	Car Components	.1-1
1.2	Car	.1-1
1.3	Crawler Components	.1-2
1.4	Crawler	.1-2
1.5	Mechanical Components	.1-2
1.6	Car Manual Control Panel	.1-4
1.7	Crawler Manual Control Station	.1-5

### SECTION 2 MECHANICAL OPERATION

2.1	Transport Cured Rack to Side Shifter	.2-1
2.2	Retrieving a Green Rack	.2-2
2.3	Transporting a Green Rack	.2-3
2.4	Retrieving a Cured Rack	.2-4
2.5	Transporting a Cured Rack	.2-5
2.6	Retrieving Green Rack from Side Shifter	.2-6
2.7	Transporting a Green Rack	.2-7
2.8	Retrieving a Cured Rack	.2-8

### SECTION 3 CAR CONTROL SYSTEMS

3.1	Car Control Panel	.3-1
3.2	Car Manual Controls	.3-2
3.3	Car Graphic Control Screen	3-3
3.4	Main Menu Screen	.3-4
3.5	Car Program Screen	.3-5
3.6	Crawler Fault Diagnostic Screen	.3-6
3.7	Rack Shuttle Main Menu Screen	.3-8
3.8	Rack Shuttle Program Screen	.3-9
3.9	Kiln Sequence Table Screen	.3-10
3.10	Kiln Map Screen	.3-11
3.11	Electrical Part Numbers Screen	.3-12
3.12	Transfer Car Switch Locations Screen	.3-13

3.13 Input/Output Status Screen . . . . .	3-15
3.14 Car Sensor Locations . . . . .	3-16
3.15 Raillock Operation . . . . .	3-18
3.16 Car Input/Output Modules . . . . .	3-19
<b>SECTION 4 CRAWLER CONTROL STATION</b>	
4.1 Crawler Control Station . . . . .	4-1
4.2 Crawler Sensor Locations . . . . .	4-2
4.3 Crawler Input/Output Modules . . . . .	4-4
<b>SECTION 5 MAINTENANCE</b>	
5.1 Sensor Adjustments . . . . .	5-1
5.2 Pipe Threads . . . . .	5-2
5.3 Flare Fitting . . . . .	5-3
5.4 Hydraulic Filter . . . . .	5-3
5.5 Cable Reel Assembly . . . . .	5-6
5.6 Cable Winding . . . . .	5-6
5.7 Spring Replacement . . . . .	5-7
5.8 Lithium Battery and EEPROM . . . . .	5-10
<b>SECTION 6 TROUBLESHOOTING</b>	
6.1 Car Battery, Fuses, EEPROM and Circuit Breakers . . . . .	6-2
6.2 Crawler Battery, Fuses, EEPROM and Circuit Breakers . . . . .	6-3
6.3 External Hydraulic Valves . . . . .	6-4

# LSC-40C

## LIST OF TABLES

### SECTION 6 TROUBLESHOOTING

3.1	Crawler Fault Diagnostics . . . . .	3-7
3.2	Transfer Car Fault Diagnostics . . . . .	3-12
3.3	Car Sensor Functions . . . . .	3-16
3.4	Car Input/Output Signals . . . . .	3-19
4.1	Crawler Sensor Functions . . . . .	4-3
4.2	Crawler Input/Output Signals . . . . .	4-5
5.1	Maintenance Time Table . . . . .	5-7



# LSC-40C SPECIFICATIONS

**TOTAL WEIGHT:**

CAR: 3,700 pounds [1,682 kg]

CRAWLER: 4,250 pounds [1,932 kg]

**MINIMUM HYDRAULIC PRESSURE:** 850 psi [59 bar]

**MACHINE SPEED:** Up to 10 cycles per minute

**PRODUCTION CAPACITY:** Up to 3 bay x 9 high x 6 deep

**PALLET REQUIREMENTS:**

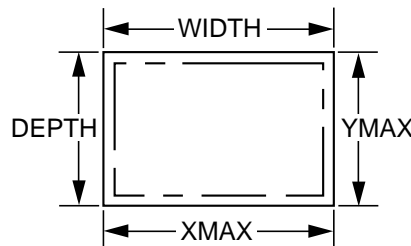

**WIDTH & DEPTH** = Actual size of steel pallet.

**XMAX & YMAX** = Maximum production area of steel pallet.

WIDTH	DEPTH	THICK	X	Y	PALLET #
26.000 (660)	18.500 (470)	.313 (8)	25.000 (635)	17.500 (445)	470750F0001
26.000 (660)	20.500 (521)	.313 (8)	25.000 (635)	19.500 (495)	470750F0002
26.000 (660)	26.000 (660)	.313 (8)	25.000 (635)	25.000 (635)	470750F0003
29.000 (737)	18.500 (470)	.313 (8)	28.000 (635)	17.500 (445)	470750F0004
29.000 (737)	20.500 (470)	.313 (8)	28.000 (635)	19.500 (495)	470750F0005
35.433 (900)	21.654 (550)	.315 (8)	34.433 (875)	20.654 (525)	470750F0006
37.000 (940)	21.654 (550)	.375 (10)	36.000 (914)	20.654 (525)	470750F0007
37.000 (940)	18.500 (470)	.375 (10)	36.000 (914)	17.500 (445)	470750F0008
37.000 (940)	20.500 (521)	.375 (10)	36.000 (914)	19.500 (495)	470750F0009
37.000 (940)	26.000 (660)	.375 (10)	36.000 (914)	25.000 (635)	470750F0010
37.750 (940)	18.500 (470)	.375 (10)	36.750 (934)	17.500 (445)	470750F0011
38.500 (978)	18.500 (470)	.375 (10)	37.500 (953)	17.500 (445)	470750F0012
38.500 (978)	20.500 (521)	.375 (10)	37.500 (953)	19.500 (495)	470750F0013
38.500 (978)	26.000 (660)	.375 (10)	37.500 (953)	25.000 (635)	470750F0014
39.375 (1000)	18.500 (470)	.375 (10)	38.375 (975)	17.500 (445)	470750F0015
39.375 (1000)	20.500 (521)	.375 (10)	38.375 (975)	19.500 (495)	470750F0016

**Table A** Steel Pallet Specifications

**OPERATING CONDITIONS:**

Besser machinery and equipment is designed to comply with the essential health and safety regulations (EHSR) that apply to directives which are applicable to an industrial environment.

Buyer shall utilize this equipment in a manner consistent with its design and only in an industrial environment.

**OPERATING RANGES:**

Here are the normal operating ranges for machine sensors (limit, proximity) and control devices contained within the control panels.

**Ambient operating temperature range:**

32° to 122°F [0° to 50°C]

**Humidity range:**

10 to 95% (non-condensing)

**Line voltage:**

90 to 132 volts – AC 50/60 Hz

# LSC-40C ELECTRICAL DATA

PLANT POWER SUPPLY (VOLTS)	TOTAL HORSEPOWER	TOTAL KILOWATTS (KW)	CONTROL PANEL TRANSFORMER (VOLT-AMPS)	BRANCH CIRCUIT DISTRIBUTION SEARCH (AMPS)	BRANCH CIRCUIT FUSE PRS-R (AMPTS)	BRANCH CIRCUIT FEEDER THHN	BRANCH CIRCUIT FEEDER CONDUIT	SHORT CIRCUIT INTERRUPTING CAPACITY (AIC)
380V 50 HZ	10	7.5	1250	60	35	10 AWG 5.3 MM <sup>2</sup>	.5 IN 15 MM	200,000
415V 50 HZ	10	7.5	1250	30	30	10 AWG 5.3 MM <sup>2</sup>	.5 IN 15 MM	200,000
440V-480V 50HZ	10	7.5	1250	30	30	10 AWG 5.3 MM <sup>2</sup>	.5 IN 15 MM	200,000
440V-480V 60 HZ	10	7.5	1250	30	30	10 AWG 5.3 MM <sup>2</sup>	.5 IN 15 MM	200,000
575V 60 HZ	10	7.5	1250	30	20	10 AWG 5.3 MM <sup>2</sup>	.5 IN 15 MM	200,000

**Table B** Electrical Data

Please consult the table above to find the appropriate electrical data for your LSC-40C. First, find your corresponding plant power supply in the left column. Then find the corresponding electrical data on the same row as your power plant supply.

**Ex:** Your power plant supply is 460V at 60 Hz. According to the table, you will then get these values:

















- PLANT POWER SUPPLY:** 460 volt – 60 hertz
- TOTAL HORSEPOWER:** 10
- TOTAL KILOWATTS:** 7.5
- TOTAL ELECTRICAL CAPACITY:** 10.0 Hp [7.46 Kw]
- CAR PANEL CONTROL TRANSFORMER:** 750 volt-amps
- CRAWLER PANEL CONTROL TRANSFORMER:** 500 volt-amps
- BRANCH CIRCUIT**
  - Distribution Switch Recommended: 30 amp
  - Fuse Recommended [FRS–R]: 30 amp
  - Feeder Recommended [THHN]: No. 10 AWG – [5.3 sq. mm]
  - Feeder Conduit Recommended: 0.5 in. – [15 mm]
  - Short Circuit Interrupting Capacity: 200,000 AIC

## SAFETY BULLETIN

This notice is issued to advise you that some previously accepted shop practices may not be keeping up with changing Federal and State Safety and Health Standards. Your current shop practices may not emphasize the need for proper precautions to insure safe operation and use of machines, tools, automatic loaders and allied equipment and/or warn against the use of certain solvents or other cleaning substances that are now considered unsafe or prohibited by law. Since many of your shop practices may not reflect current safety practices and procedures, particularly with regard to the safe operation of equipment, it is important that you review your practices to ensure compliance with Federal and State Safety and Health Standards.

### IMPORTANT

**The operation of any machine or power-operated device can be extremely hazardous unless proper safety precautions are strictly observed. Observe the following safety precautions:**

-  Always be sure proper guarding is in place for all pinch, catch, shear, crush and nip points.
-  Always make sure that all personnel are clear of the equipment before starting it.
-  Always be sure the equipment is properly grounded.
-  Always turn the main electrical panel off and lock it out in accordance with published lockout/tag-out procedures prior to making adjustments, repairs, and maintenance.
-  Always wear appropriate protective equipment like safety glasses, safety shoes, hearing protection and hard hats.
-  Always keep chemical and flammable material away from electrical or operating equipment.
-  Always maintain a safe work area that is free from slipping and tripping hazards.
-  Always be sure appropriate safety devices are used when providing maintenance and repairs to all equipment.
-  Never exceed the rated capacity of a machine or tool.
-  Never modify machinery in any way without prior written approval of the Besser Engineering Department.
-  Never operate equipment unless proper maintenance has been regularly performed.
-  Never operate any equipment if unusual or excessive noise or vibration occurs.
-  Never operate any equipment while any part of the body is in the proximity of potentially hazardous areas.
-  Never use any toxic flammable substance as a solvent cleaner.
-  Never allow the operation or repair of equipment by untrained personnel.
-  Never climb or stand on equipment when it is operational.

It is important that you review Federal and State Safety and Health Standards on a continual basis. All shop supervisors, maintenance personnel, machine operators, tool operators, and any other person involved in the setup, operation, maintenance, repair or adjustment of Besser-built equipment should read and understand this bulletin and Federal and State Safety and Health Standards on which this bulletin is based.

**SAFETY SIGNS**

<b>Sign</b>	<b>Description</b>	<b>Required</b>
1	All Panels .....	1
2	Mixer .....	4
3	Concrete Products Machine.....	1
	Depalleter.....	2
4	Mixer .....	2
5	Skiploader .....	4
6	Skiploader/Mixer Platforms .....	8
7	Skiploader/Mixer Platforms .....	8
8	Vertical: Pallet Transport System .....	2
	Horizontal: LSC-40/LSC-100.....	6
	Pallet Transport System .....	4
9	Besser-Matic .....	4
10	Besser-Matic .....	4
11	Skiploader .....	4
12	All Panels .....	1
13	Overhead Block Transfer .....	4
14	Concrete Products Machine.....	1
15	Concrete Products Machine.....	2
16	Conveyors .....	12
17	Cuber .....	8
18	Cuber .....	3
	Block Turnovers.....	2
	Slat Conveyors.....	2

**To order safety decals, contact your local Besser representative  
or the Besser Central Order Department.  
Thank you!**



**1**  
**Large 113236F0409**  
High Voltage  
Width 4 1/2 inch  
Height 9 5/8 inch  
**Small 113236F0204**  
High Voltage  
Width 2 inch  
Height 4 1/8 inch



**2**  
**113237F0410**  
Mixer Blade Hazard  
Width 4 1/2 inch  
Height 10 1/4 inch



**3**  
**113240F0307**  
Crush Hazard  
Width 3 1/2 inch  
Height 7 1/2 inch



**4**  
**114692F1006**  
Nip Points  
Width 5 3/4 inch  
Height 9 1/2 inch



**5**  
**114688F0906**  
Crush Hazard  
Width 6 1/4 inch  
Height 9 1/2 inch



**6**  
**114689F0804**  
Fall Hazard  
Width 4 1/2 inch  
Height 7 3/4 inch



**7**

**114690F0805**  
Falling Objects  
Width 4 3/4 inch  
Height 8 inch



**8**

**Vertical: 113245F0704**  
Crush Hazard  
Width 4 1/8 inch  
Height 7 inch  
**Horizontal: 113245F1005**  
Crush Hazard  
Width 10 inch  
Height 5 3/4 inch



**9**

**113242F0409**  
Crush Hazard  
Width 4 1/2 inch  
Height 9 5/8 inch



**10**

**113243F0410**  
Falling Objects  
Width 4 1/2 inch  
Height 10 inch



**11**

**114691F1006**  
Shear and Fall Hazards  
Width 5 3/4 inch  
Height 9 3/4 inch

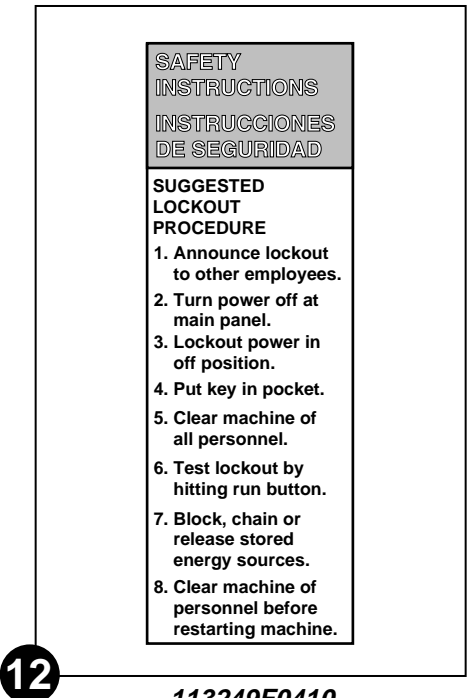

**12**

**113249F0410**  
Safety Instructions Decal –  
Suggested Lock-out Procedure  
Width 4 inch  
Height 10 inch

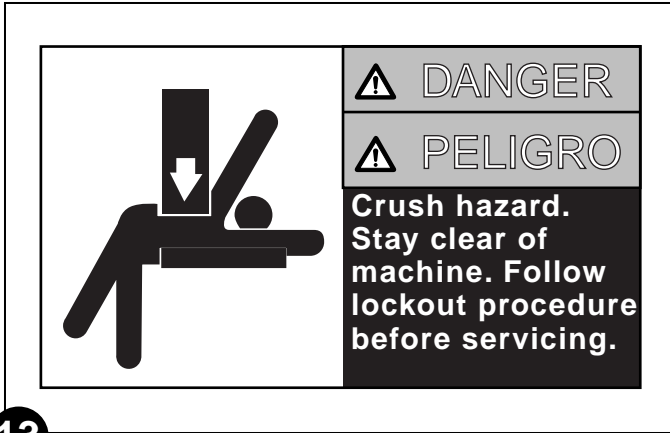

**13**

**113238F1005**  
Crush Hazard  
Width 10 inch  
Height 5 3/4 inch



**14**

**113239F0604**  
Crush Hazard  
Width 6 5/8 inch  
Height 4 inch

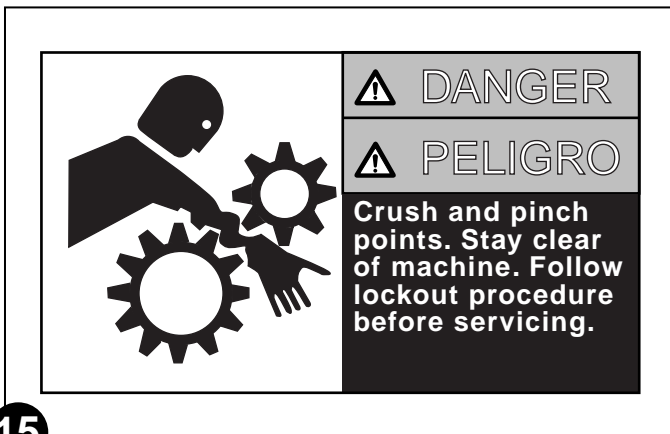

**15**

**113241F0605**  
Crush and Pinch Points  
Width 6 5/8 inch  
Height 4 inch

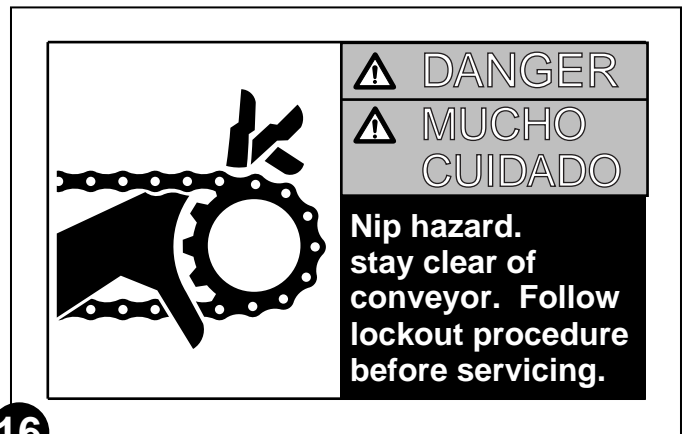

**16**

**113246F0704**  
Nip Hazard  
Width 7 inch  
Height 4 1/2 inch

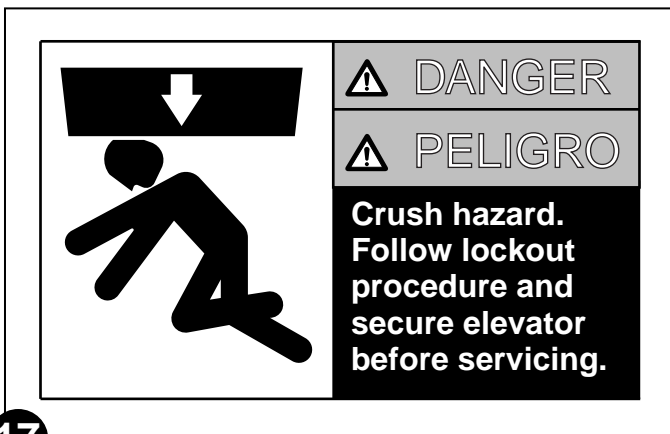

**17**

**113427F1006**  
Crush Hazard  
Width 10 inch  
Height 6 inch



**18**

**113250F1006**  
Crush and Pinch Hazard  
Width 10 inch  
Height 6 inch



# SECTION 1

## INTRODUCTION

The LSC-40C is an automated concrete product transport system. The LSC-40C transfers racks of green concrete product back and forth from the Loader/Unloader area to kilns for curing. The LSC-40C consists of a rail network, two mobile vehicles, and a programmable logic controller system.

### 1.1 MECHANICAL COMPONENT OVERVIEW

Figures 1.1 through 1.5 illustrate the basic mechanical components of the LSC-40C system.

#### 1.1.1 Racks

The racks carry the concrete product as they move from one area to another.

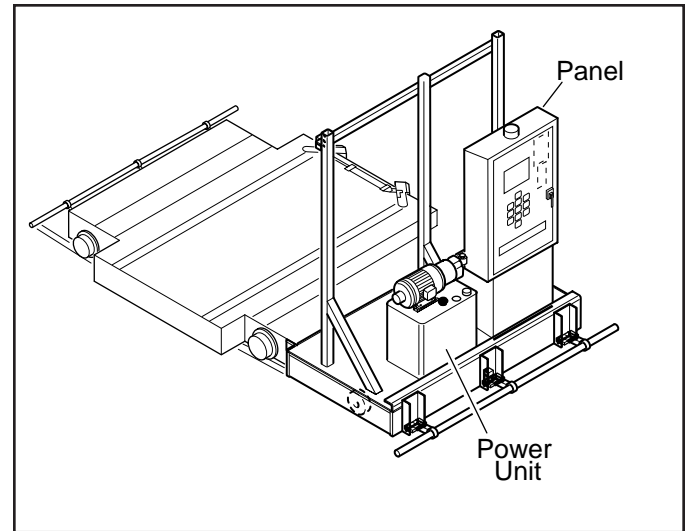

*Figure 1.2 Car*

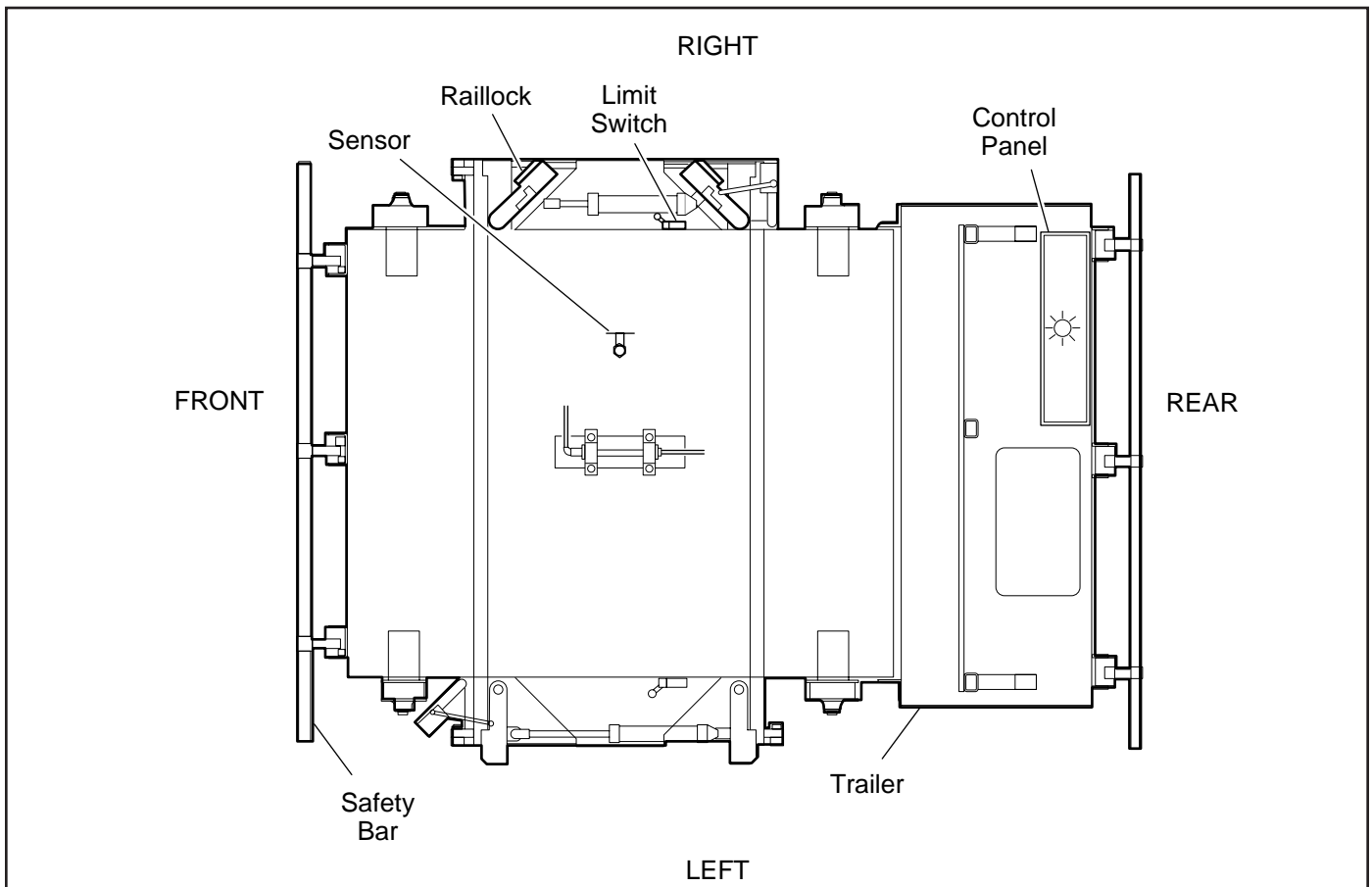

*Figure 1.1 Car Components*

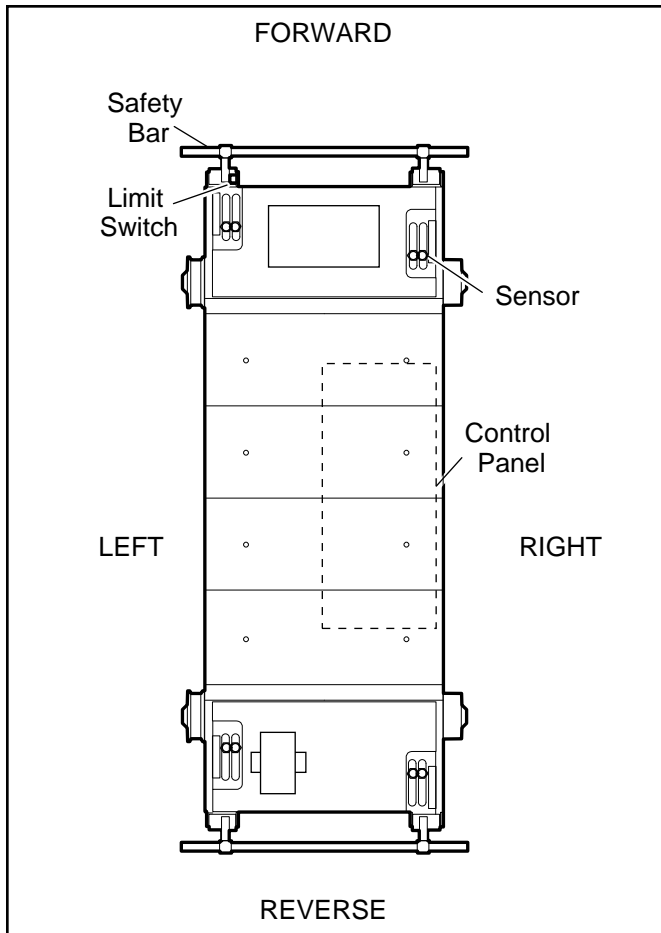

Figure 1.3 Crawler Components

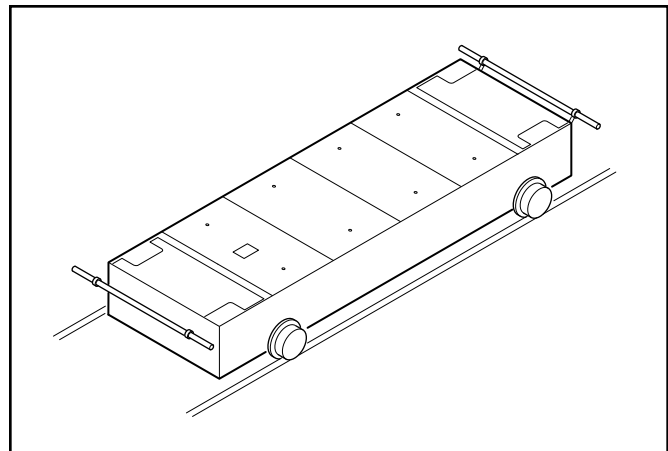

Figure 1.4 Crawler

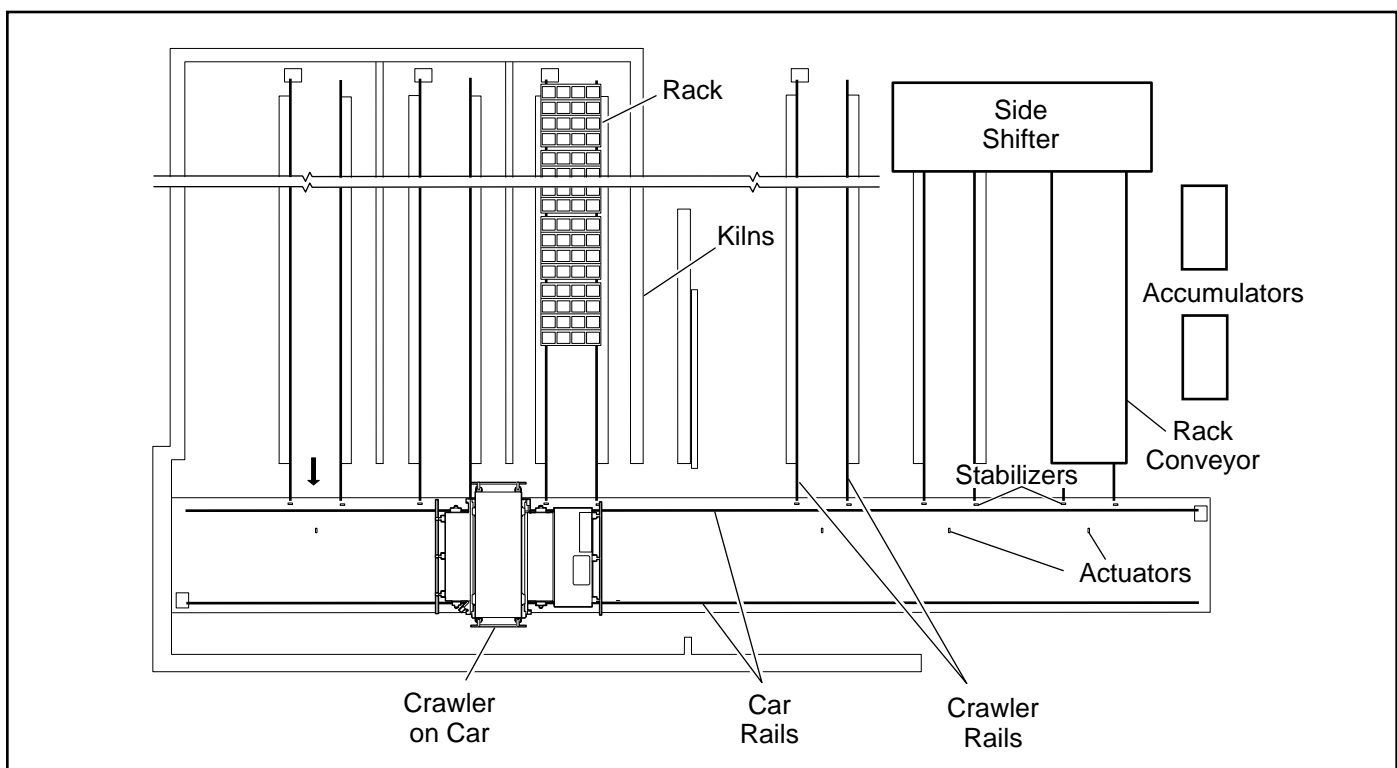

Figure 1.5 Mechanical Components

### 1.1.2 Rail System

There are two different rail paths and gauges. Wide gauge rails carry the car. Narrow gauge rails at right angles to the car rails carry the crawler to the side shifter, the rack conveyor and into the kilns.

### 1.1.3 Crawler

The crawler lifts and transports racks between the car and the:

- Side shifter
- Rack conveyor
- Kilns

### 1.1.4 Car

The car carries the crawler between the Loader/Unloader area and the kiln area.

### 1.1.5 Side Shifter

The side shifter loads, shifts and stores racks until removed by the crawler.

### 1.1.6 Rack Conveyor

The rack conveyor receives cured racks from the crawler and transports them to the Unloader.

## 1.2 ELECTRONIC COMPONENT OVERVIEW

A range of electronic components monitor and control LSC-40C operation. This section provides only a brief overview of three components that are fundamental to the mechanical operation of the system:

- Logic controller/graphic control station
- Sensors
- Actuators

Sections 3 and 4 provide details of electronic components including sensor function.

### 1.2.1 Small Logic Controller/Graphic Control Station

Both car and crawler have Small Logic Controllers (SLC-500) which control the sequence of operations of each vehicle. The car's graphic control station functions as a man-machine interface. The crawler has two control stations located at each end of the crawler. The control stations use indicator lamps to show operational status and faults.

### 1.2.2 Sensors

Sensors located on the car and crawler monitor and control all mechanical operations. Sensors are also essential to the LSC-40C safety protection system. There are three types of sensors:

- Limit switches (LS) are spring-loaded electromechanical devices that monitor the position of:
  - Safety bars on both the car and crawler
  - Car raillocks
- Proximity sensors (PRS) on both the car and the crawler monitor a magnetic field to signal various operating conditions. For example, upward-sensing PRSs on the crawler detect the presence of a rack as part of the control process for crawler movement. Downward-sensing PRSs on the car detect floor-level actuators as part of the control process for car movement.
- A photo-electric sensor (PER) provides a light and reflection process as a means by which crawler movements are controlled when traveling on the rails leading to the side shifter.

### 1.2.3 Actuators

Actuators are floor-level steel plates installed on the centerline of every set of crawler rails. Downward-sensing proximity sensors on the car use the actuators to help control car movement.

**1.3 START-UP PROCEDURE**

Refer to Figures 1.6 and 1.7.

1. Ensure all switches are off.
2. Turn the power on. The indicator light will illuminate.
3. Pull out the emergency stop. Press the energize MCR push button.
4. Turn the pump on.
5. Turn hand-off-auto switch to hand.
6. Manually position the car in front of any station.
7. Ensure that the screen has been properly programmed.
8. Turn the hand-off-auto switch to auto.



**WARNING:**  
The horn blows for 2 seconds prior to the car moving. In case of emergency press the emergency stop.

9. Press auto start push button.

**1.4 SHUT-DOWN PROCEDURE**

Refer to Figures 1.6 and 1.7.

1. Ensure that the machine has stopped at a chosen location.
2. Turn hand-off-auto switch to off.
3. Depress and lock emergency stop switch.
4. If maintaining warm oil is desired, turn the oil heater switch on.
5. If warm oil is not required, turn power off.

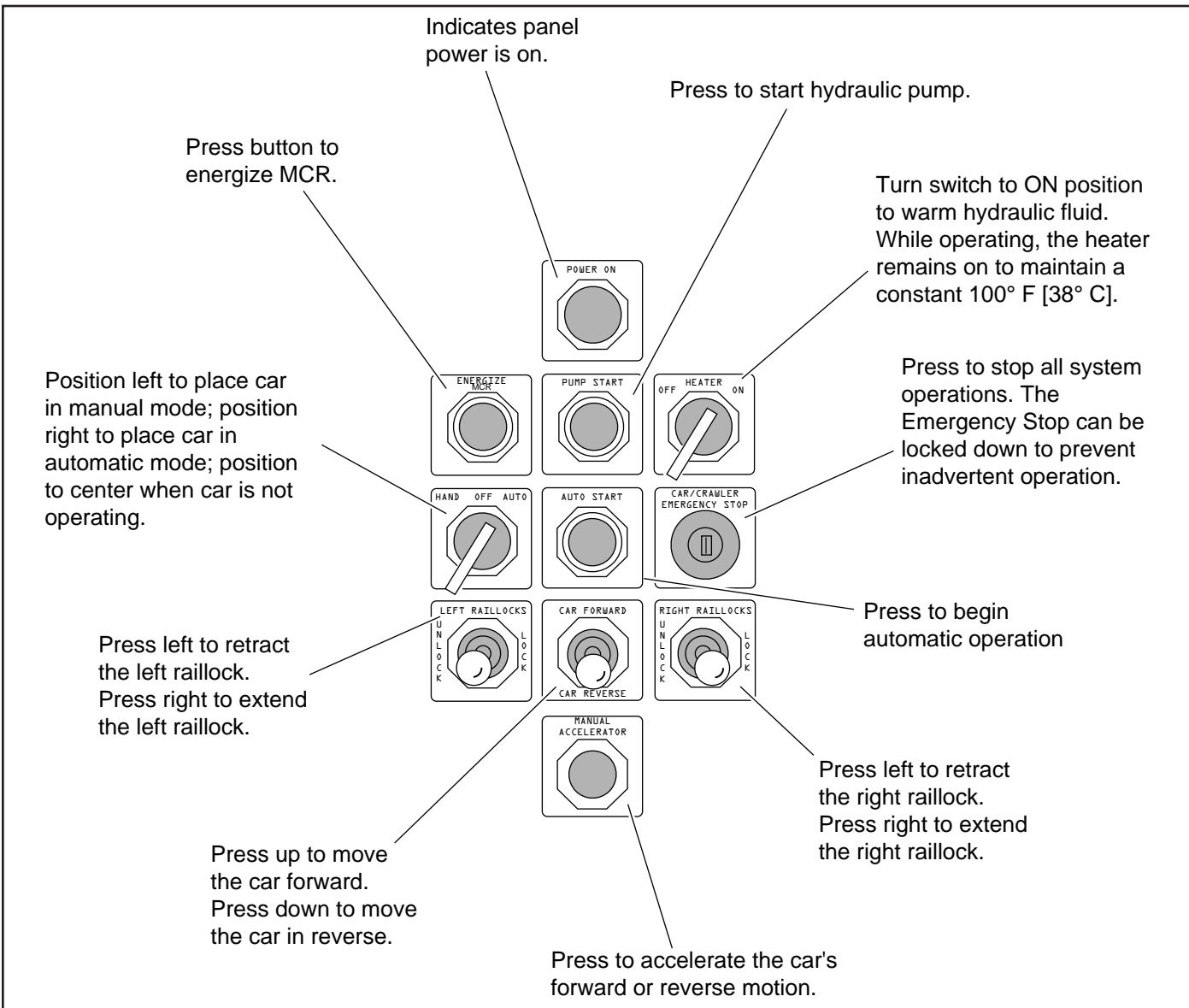

**Figure 1.6** Car Manual Control Panel

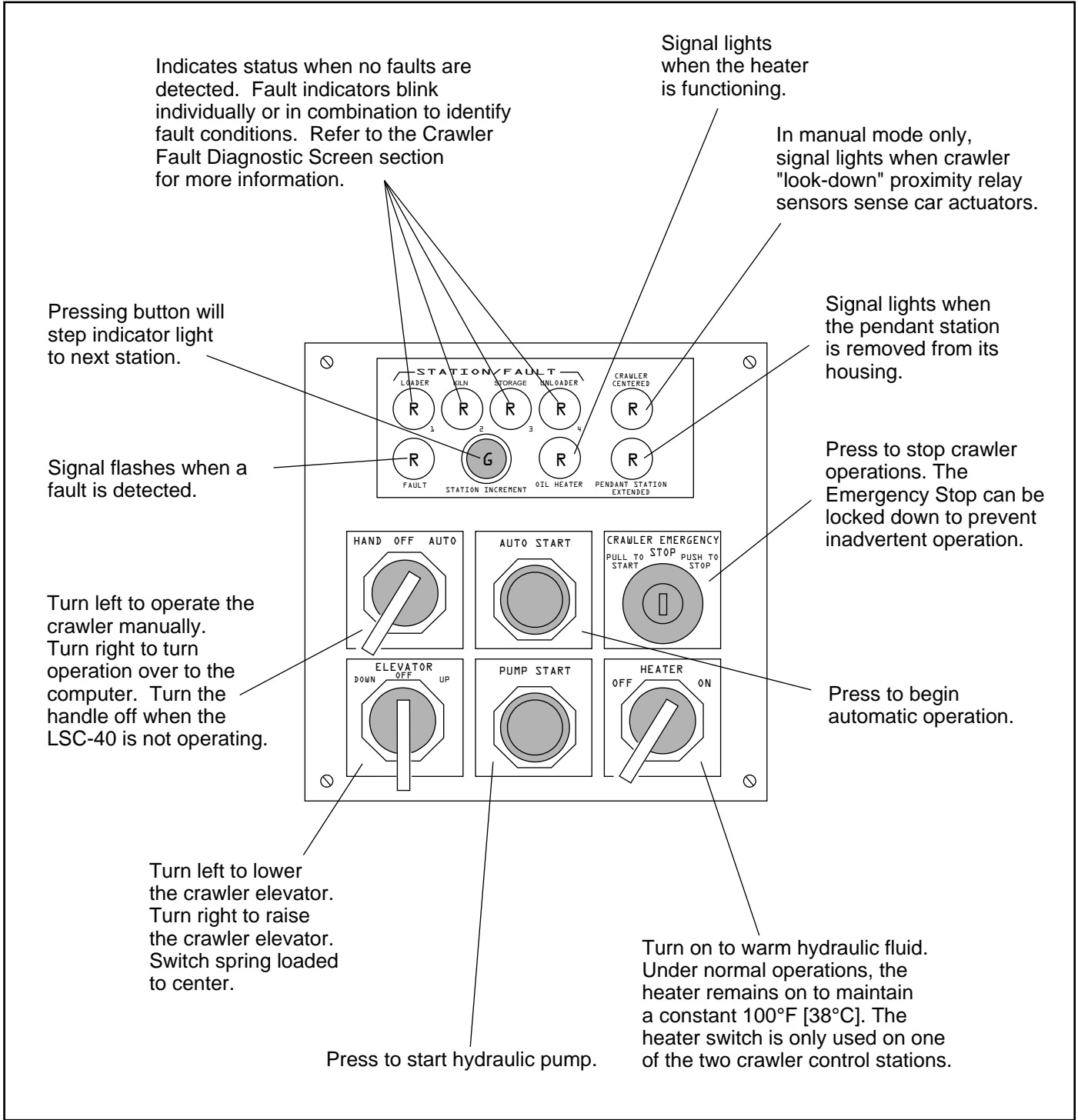

**Figure 1.7** Crawler Manual Control Station



## SECTION 2

### MECHANICAL OPERATION

This section is an overview of LSC-40C operation with a focus on mechanical systems and movement of components. Steps in a typical operating cycle of the Unloader side shifter are:

- 2.1 Transport Cured Rack to Side Shifter
  - 2.2 Retrieve Green Rack from Rack Conveyor
  - 2.3 Transport Green Rack to Kiln
  - 2.4 Retrieve Cured Rack from Storage
- Steps in a typical operating cycle of the Loader side shifter are:

- 2.5 Transport Cured Rack to Rack Conveyor
- 2.6 Retrieve Green Rack from Side Shifter
- 2.7 Transport Green Rack to Kiln
- 2.8 Retrieve Cured Rack from Storage

#### 2.1 TRANSPORT CURED RACK TO SIDE SHIFTER

Figure 2.1 shows the sequence to transport cured rack to side shifter.

1. The car stops and locks at the rails leading to the side shifter.
2. The raillocks extend and the crawler immediately moves off the car at fast speed.
3. If PER-101 at the wait station is on, the crawler proceeds towards the side shifter without stopping.

4. If PER-101 at the wait station is off, PER-17 on the crawler comes in contact with the actuator signaling the crawler to decelerate. The crawler stops when its trailing sensor comes in contact with the actuator near PER-101. When the Besser-Matic signals through PER-102, the crawler moves at fast speed onto the side shifter.
5. The leading sensor on the crawler comes in contact with the actuator on the side shifter signaling the crawler to decelerate.
6. The crawler stops when its trailing sensor comes in contact with the actuator on the side shifter.
7. The stopped crawler is centered on the side shifter. The crawler elevator lowers to unload the cured rack.
8. The unloaded crawler moves at fast speed towards the car.
9. The crawler raillock sensors sense the car raillock actuators. When the leading sensor on the crawler comes in contact with the first car actuator, the crawler decelerates.
10. The crawler stops centered on car when the leading and trailing actuators come in contact with the car actuators.

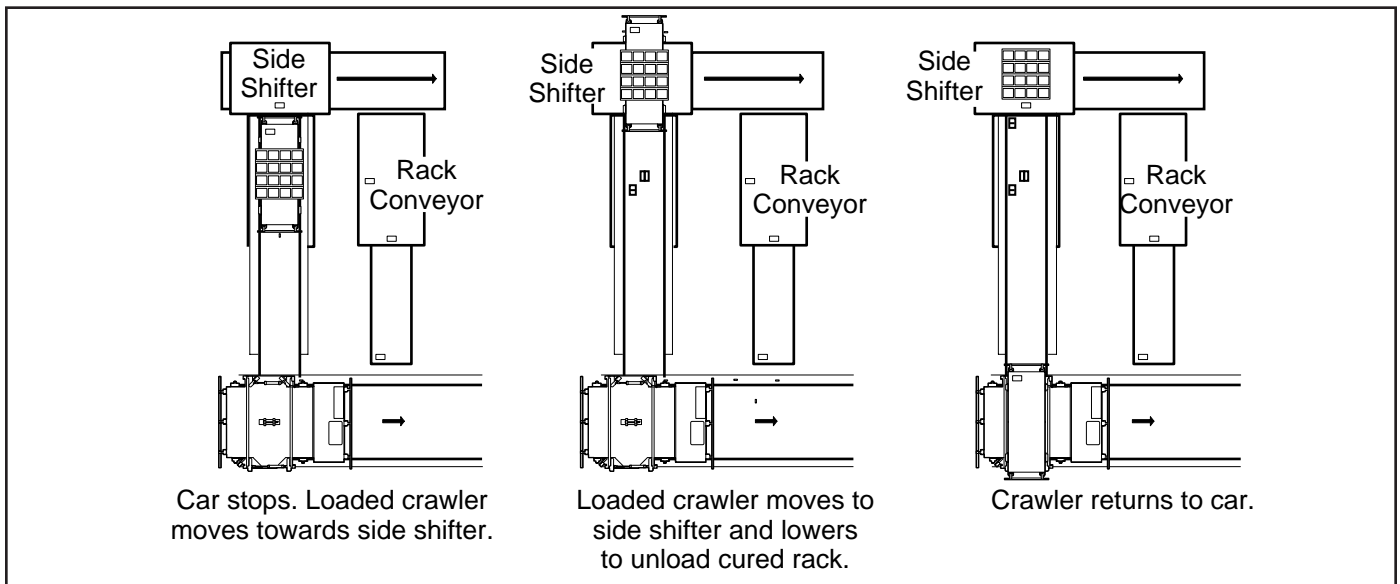
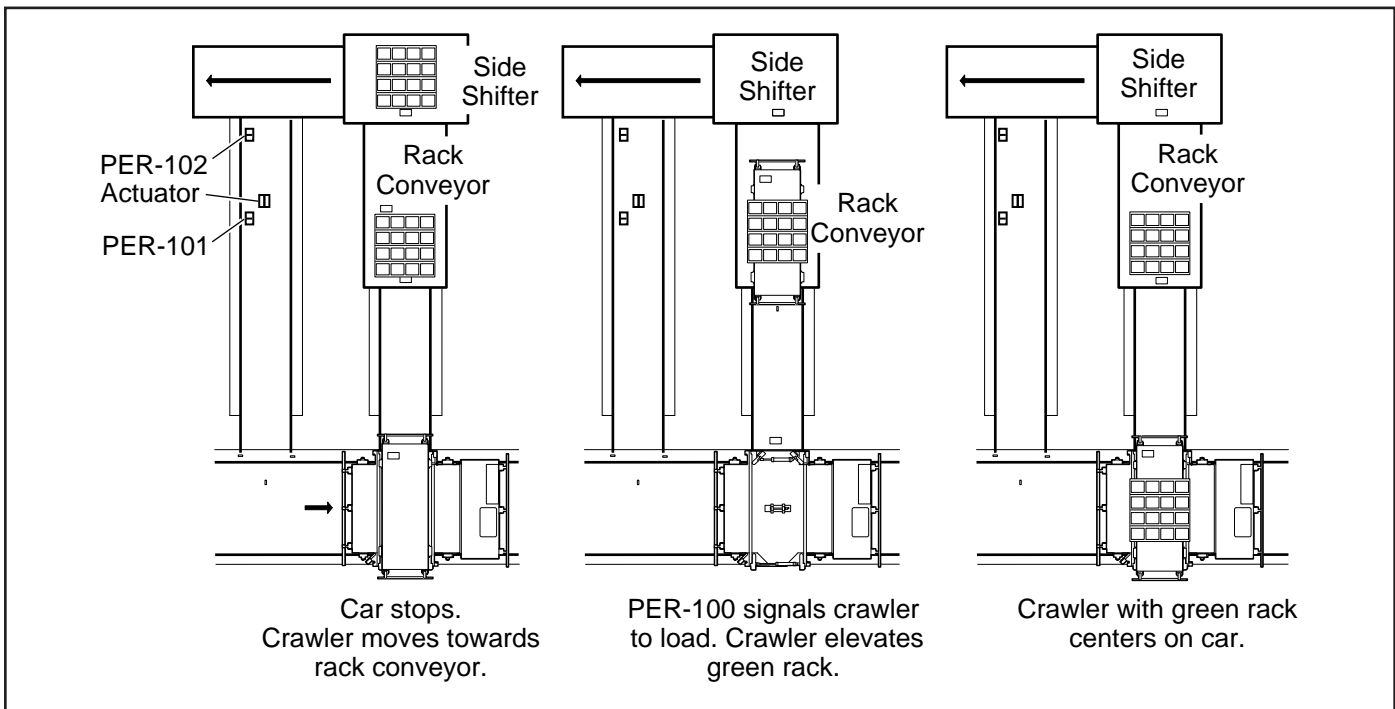

**Figure 2.1** Transport Cured Rack to Side Shifter

## 2.2 RETRIEVE GREEN RACK FROM RACK CONVEYOR

Figure 2.2 shows the sequence to retrieve a green rack.

1. The car stops and locks at the rails leading to the rack conveyor.
2. The raillocks extend and the crawler immediately moves off the car at fast speed.
3. The leading sensor on the crawler comes in contact with the actuator on the rack conveyor signaling the crawler to decelerate.
4. The crawler stops when its trailing sensor comes in contact with the actuator on the rack conveyor.
5. The crawler waits for a signal from the Besser-Matic through PER-100 to raise the crawler and load the green rack onto the crawler.
6. The loaded crawler moves at medium speed towards the car.
7. The crawler raillock sensors sense the car raillock actuators. When the leading sensor on the crawler comes in contact with the first car actuator, the crawler decelerates.
8. The crawler stops centered on car when the leading and trailing actuators come in contact with the car actuators.



**Figure 2.2** Retrieving a Green Rack



**2.3 TRANSPORT GREEN RACK TO KILN**

Figure 2.3 shows the sequence for placing a rack of green product in the kiln for curing.

1. The car moves along the car rails at fast speed. The car slows when the selected kiln actuator triggers the first downward-sensing PRS and stops when the same actuator triggers the center downward-sensing PRS.
2. The raillocks extend.
3. The loaded crawler moves off the car onto the kiln rails at slow speed.

4. The crawler stops when the “look-up” PRS pair is triggered by the edge of the first rack. If there is no rack inside the kiln, the end-of-kiln safety stop simulates the presence of a rack and causes the crawler to stop.
5. The crawler lowers the green rack onto curbs along the kiln rails.
6. The empty crawler starts in reverse direction at fast speed. The crawler slows when sensors are triggered by the car raillock actuators and stops when the crawler centers on the car.
7. The raillocks retract.

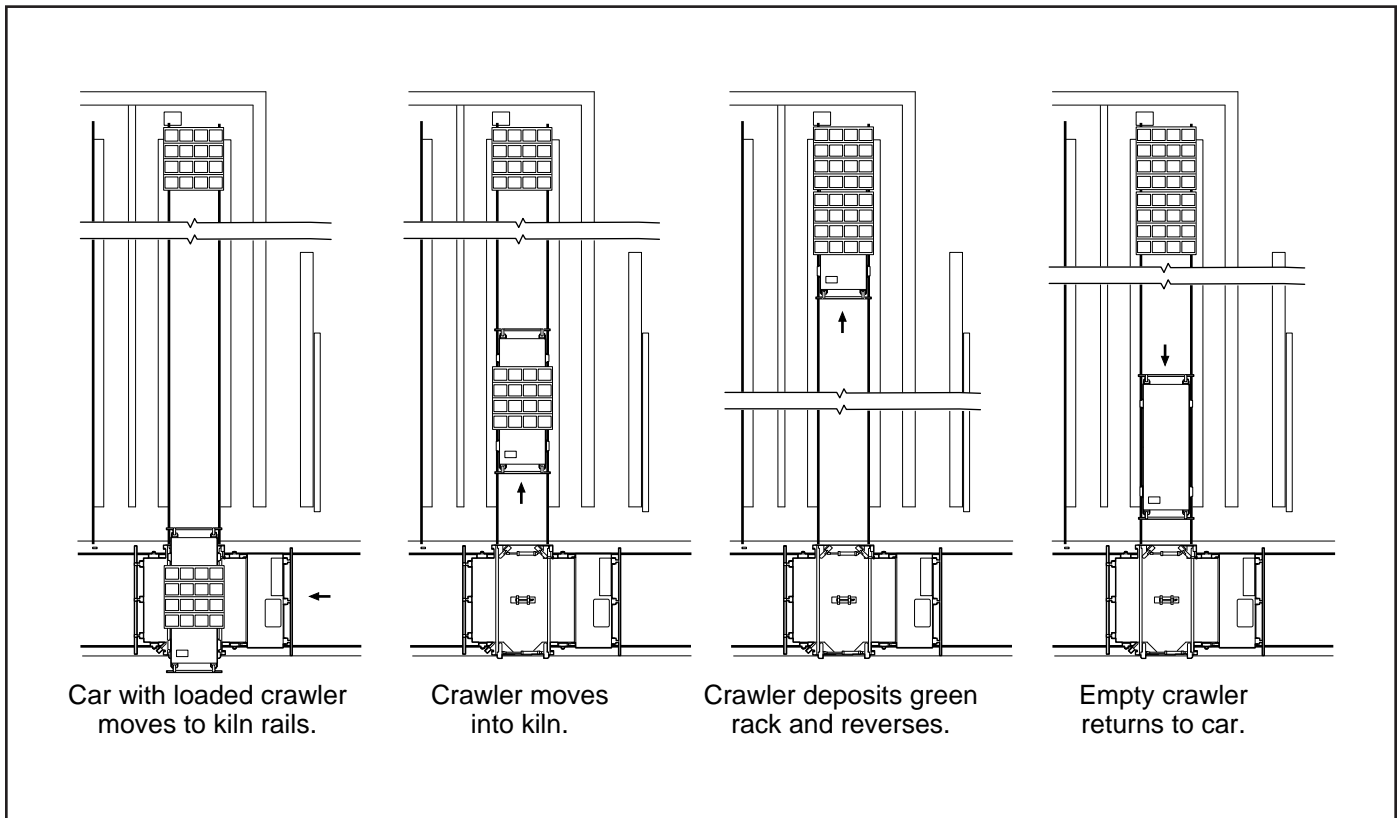
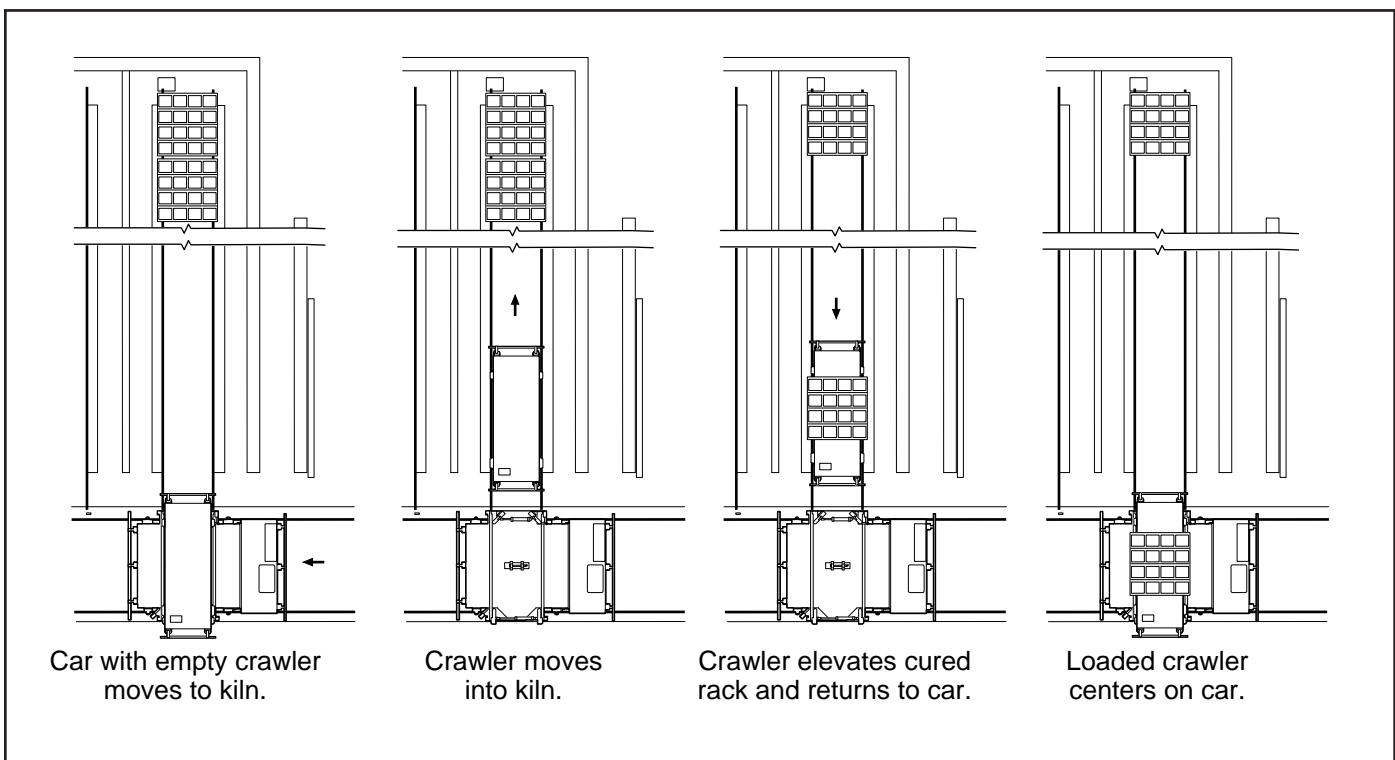

**Figure 2.3** *Transporting a Green Rack*

## 2.4 RETRIEVE CURED RACK FROM STORAGE

Figure 2.4 shows the sequence to retrieve a cured rack from a kiln.

1. The car moves along the car rails at fast speed. The car slows when the selected kiln actuator triggers the first downward-sensing PRS and stops when the same actuator triggers the center downward-sensing PRS.
2. The raillocks extend.
3. The empty crawler moves off the car onto the kiln rails at fast speed.
4. The crawler slows when the rack triggers the leading “look-up” PRS on top of the crawler and stops when the rack triggers the trailing “look-up” PRS.
5. The crawler elevator lifts the cured rack from the kiln curbs.
6. The loaded crawler starts in reverse direction at fast speed. The crawler slows when sensors are triggered by the car raillock actuators and stops when the crawler centers on the car.
7. The raillocks retract.

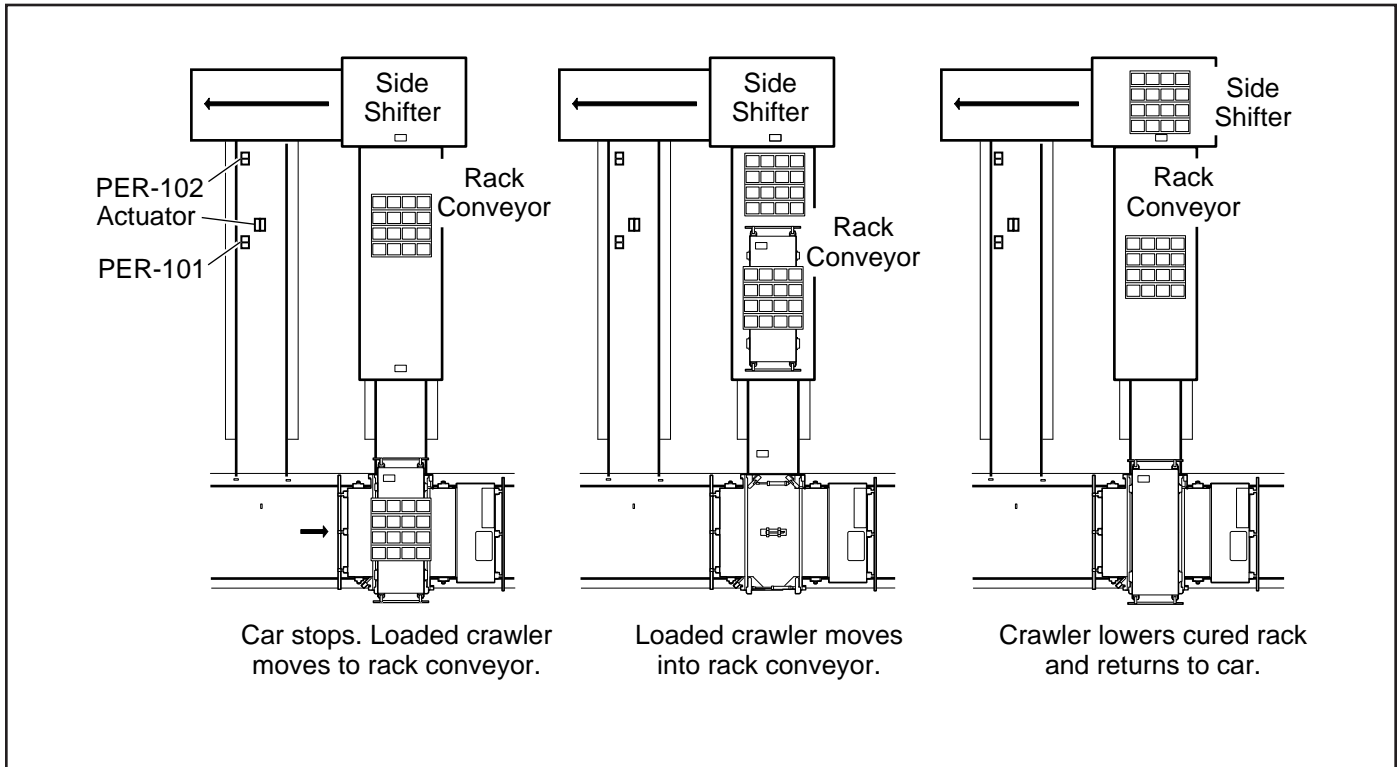

**Figure 2.4** Retrieving a Cured Rack

**2.5 TRANSPORT CURED RACK TO RACK CONVEYOR**

Figure 2.5 shows the sequence to transport a cured rack to the rack conveyor.

1. The car stops and locks at the rails leading to the rack conveyor.
2. The crawler waits for a signal from PER-100 and then proceeds forward at fast speed.
3. The leading sensor on the crawler comes in contact with the actuator on the rack conveyor signaling the crawler to decelerate.
4. The crawler stops when its trailing sensor comes in contact with the actuator on the side shifter.
5. The crawler lowers to unload the cured rack.
6. The unloaded crawler moves at fast speed towards the car.
7. The crawler raillock sensors sense the car raillock actuators. When the leading sensor on the crawler comes in contact with the first car actuator, the crawler decelerates.
8. The crawler stops centered on car when the leading and trailing actuators come in contact with the car actuators.

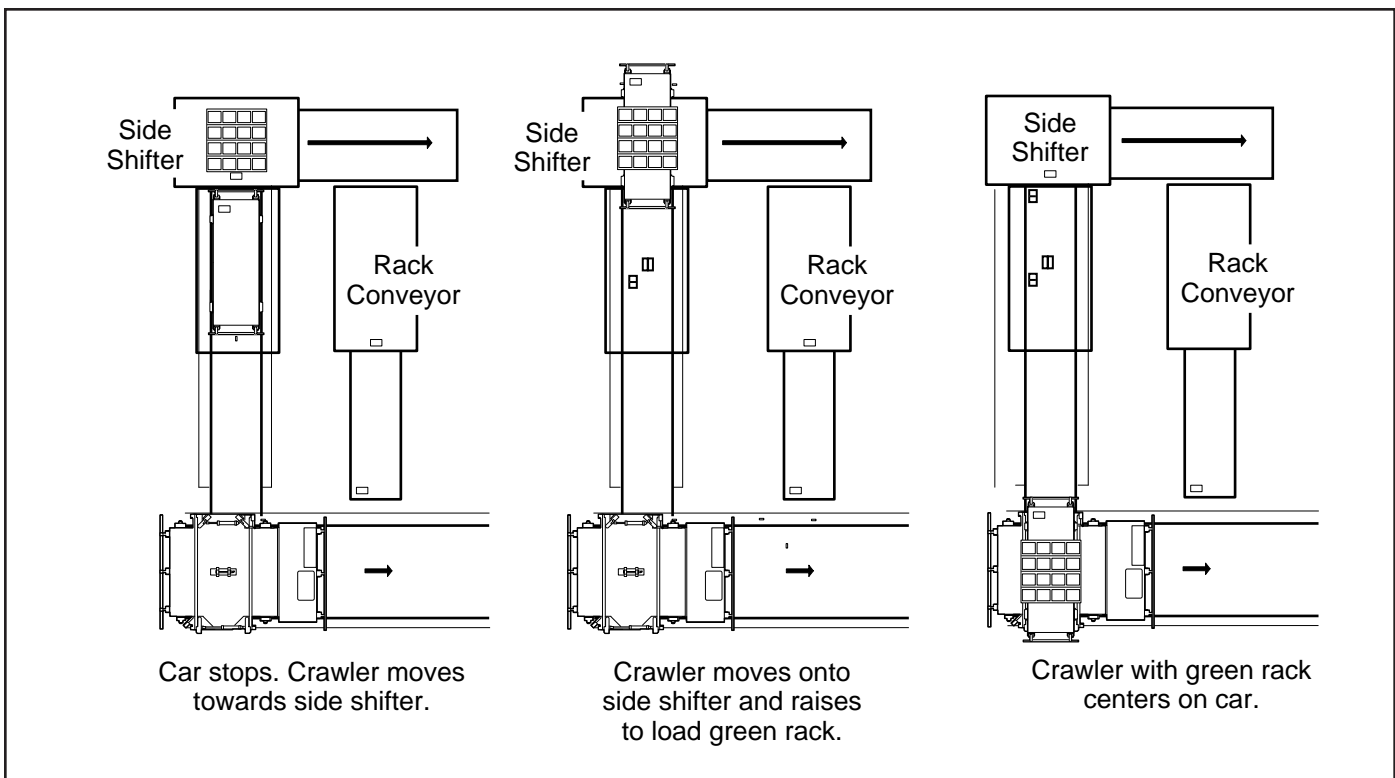

**Figure 2.5** Transporting a Cured Rack

## 2.6 RETRIEVE GREEN RACK FROM SIDE SHIFTER

Figure 2.6 shows the sequence to retrieve green rack from the side shifter.

1. The car stops and locks at the rails leading to the side shifter.
2. The raillocks extend and the crawler immediately moves off the car at fast speed.
3. If PER-101 at the wait station is on, the crawler proceeds towards the side shifter without stopping.
4. If PER-101 at the wait station is off, PER-17 on the crawler comes in contact with the actuator signaling the crawler to decelerate. The crawler stops when its trailing sensor comes in contact with the actuator near PER-101. When the Besser-Matic signals through PER-102, the crawler moves at fast speed onto the side shifter.
5. The leading sensor on the crawler comes in contact with the actuator on the side shifter signaling the crawler to decelerate.
6. The crawler stops when its trailing sensor comes in contact with the actuator on the side shifter.
7. The stopped crawler is centered on the side shifter. The crawler elevator raises to load the green rack.
8. The loaded crawler moves at medium speed towards the car.
9. The crawler raillock sensors sense the car raillock actuators. When the leading sensor on the crawler comes in contact with the first car actuator, the crawler decelerates.
10. The crawler stops centered on car when the leading and trailing actuators come in contact with the car actuators.



**Figure 2.6** Retrieving Green Rack from Side Shifter

**2.7 TRANSPORT GREEN RACK TO KILN**

Figure 2.7 shows the sequence for placing a rack of green product in the kiln for curing.

1. The car moves along the car rails at fast speed. The car slows when the selected kiln actuator triggers the first downward-sensing PRS and stops when the same actuator triggers the center downward-sensing PRS.
2. The raillocks extend.
3. The loaded crawler moves off the car onto the kiln rails at slow speed.

4. The crawler stops when the “look-up” PRS pair is triggered by the edge of the first rack. If there is no rack inside the kiln, the end-of-kiln safety stop simulates the presence of a rack and causes the crawler to stop.
5. The crawler lowers the green rack onto curbs along the kiln rails.
6. The empty crawler starts in reverse direction at fast speed. The crawler slows when sensors are triggered by the car raillock actuators and stops when the crawler centers on the car.
7. The raillocks retract.

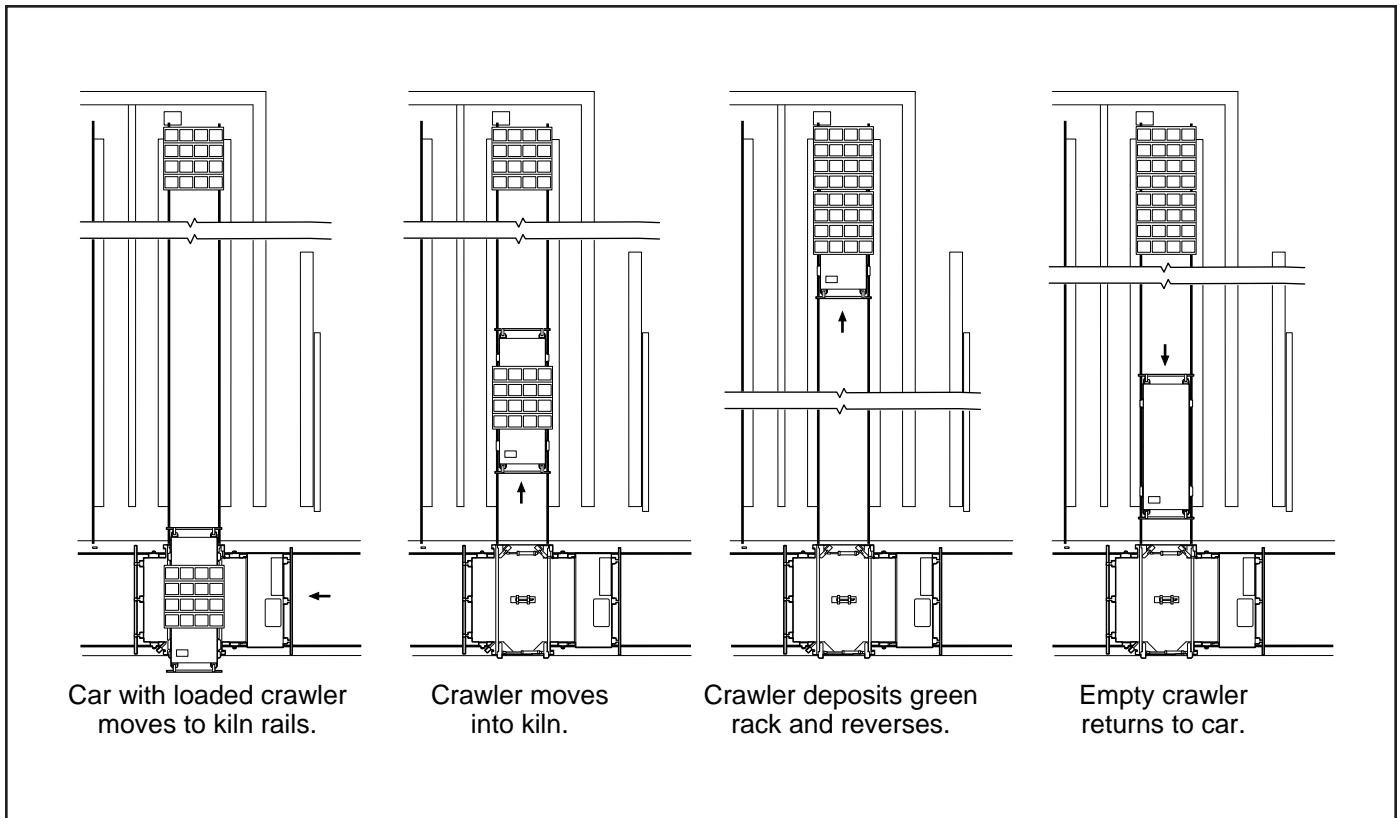
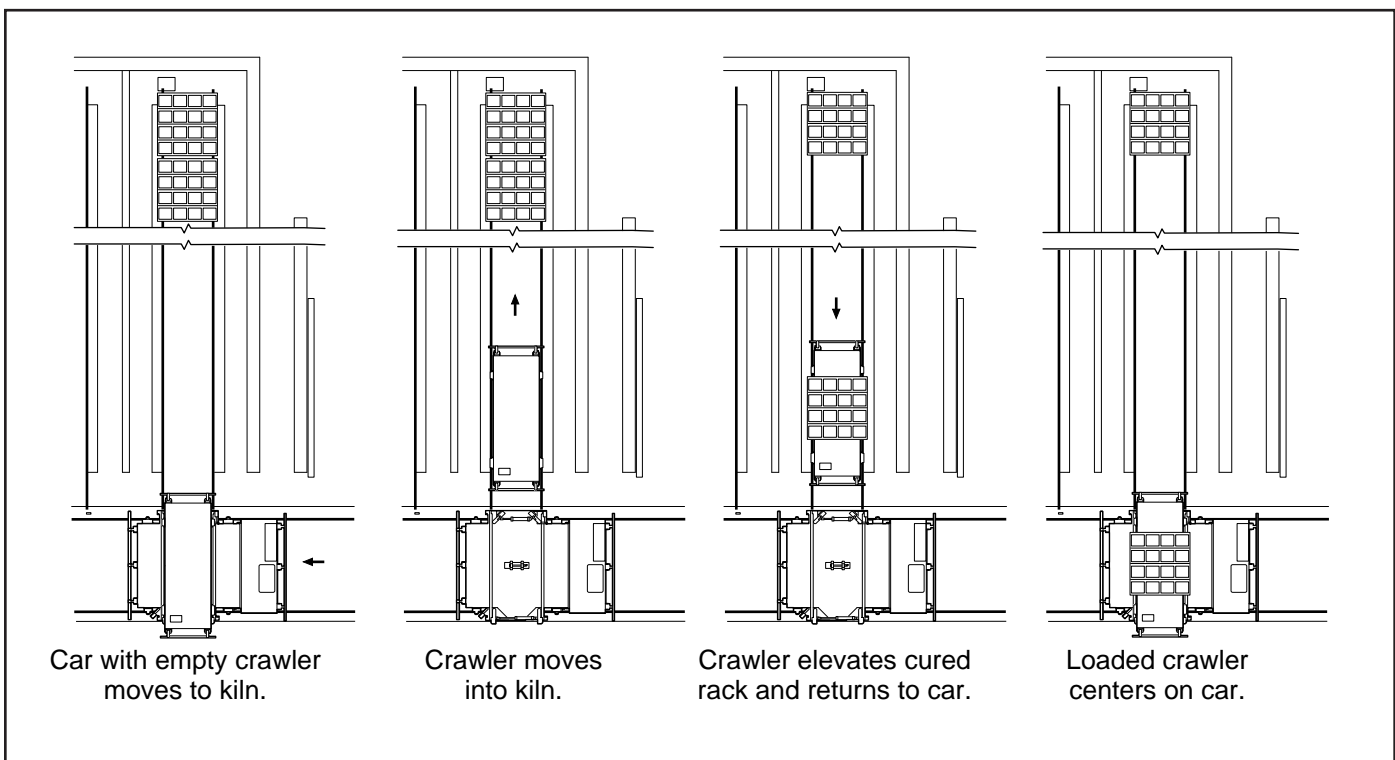

**Figure 2.7** *Transporting a Green Rack*

## 2.8 RETRIEVE CURED RACK FROM STORAGE

Figure 2.8 shows the sequence to retrieve a cured rack from a kiln.

1. The car moves along the car rails at fast speed. The car slows when the selected kiln actuator triggers the first downward-sensing PRS and stops when the same actuator triggers the center downward-sensing PRS.
2. The raillocks extend.
3. The empty crawler moves off the car onto the kiln rails at fast speed.
4. The crawler slows when the rack triggers the leading “look-up” PRS pair on top of the crawler and stops when the rack triggers the trailing “look-up” PRS pair.
5. The crawler elevator lifts the cured rack from the kiln curbs.
6. The loaded crawler starts in reverse direction at fast speed. The crawler slows when sensors are triggered by the car raillock actuators and stops when the crawler centers on the car.
7. The raillocks retract.

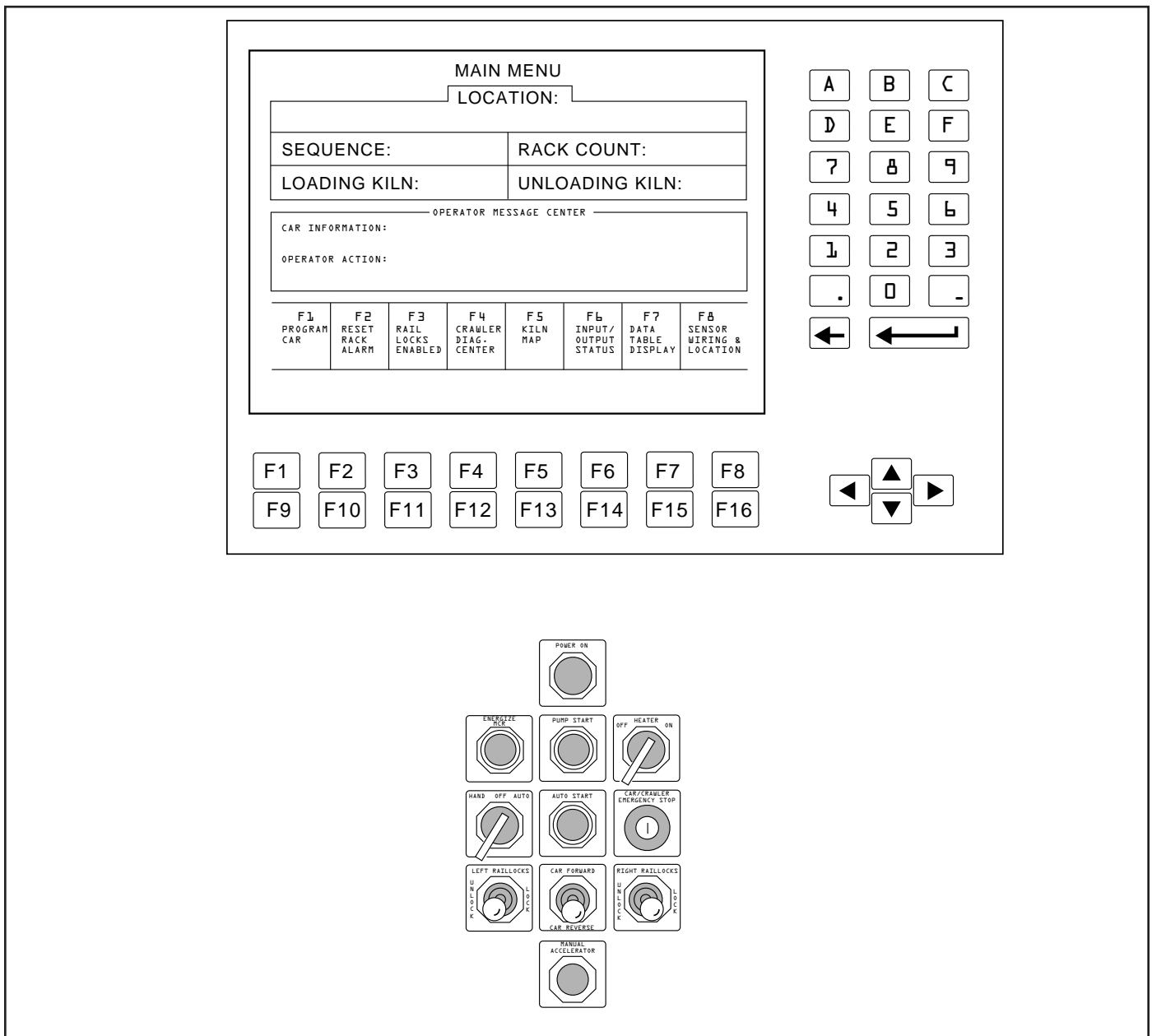

**Figure 2.8** Retrieving a Cured Rack

# SECTION 3

## CAR control systems

Figure 3.1 shows the complete car control panel with the graphic control screen on top and the manual controls below. This section discusses the man/machine interface of the LSC-40C car control systems.



**Figure 3.1** Car Control Panel

### 3.1 CAR MANUAL CONTROLS

Figure 3.2 shows the hand operated section with the function of all manual controls.

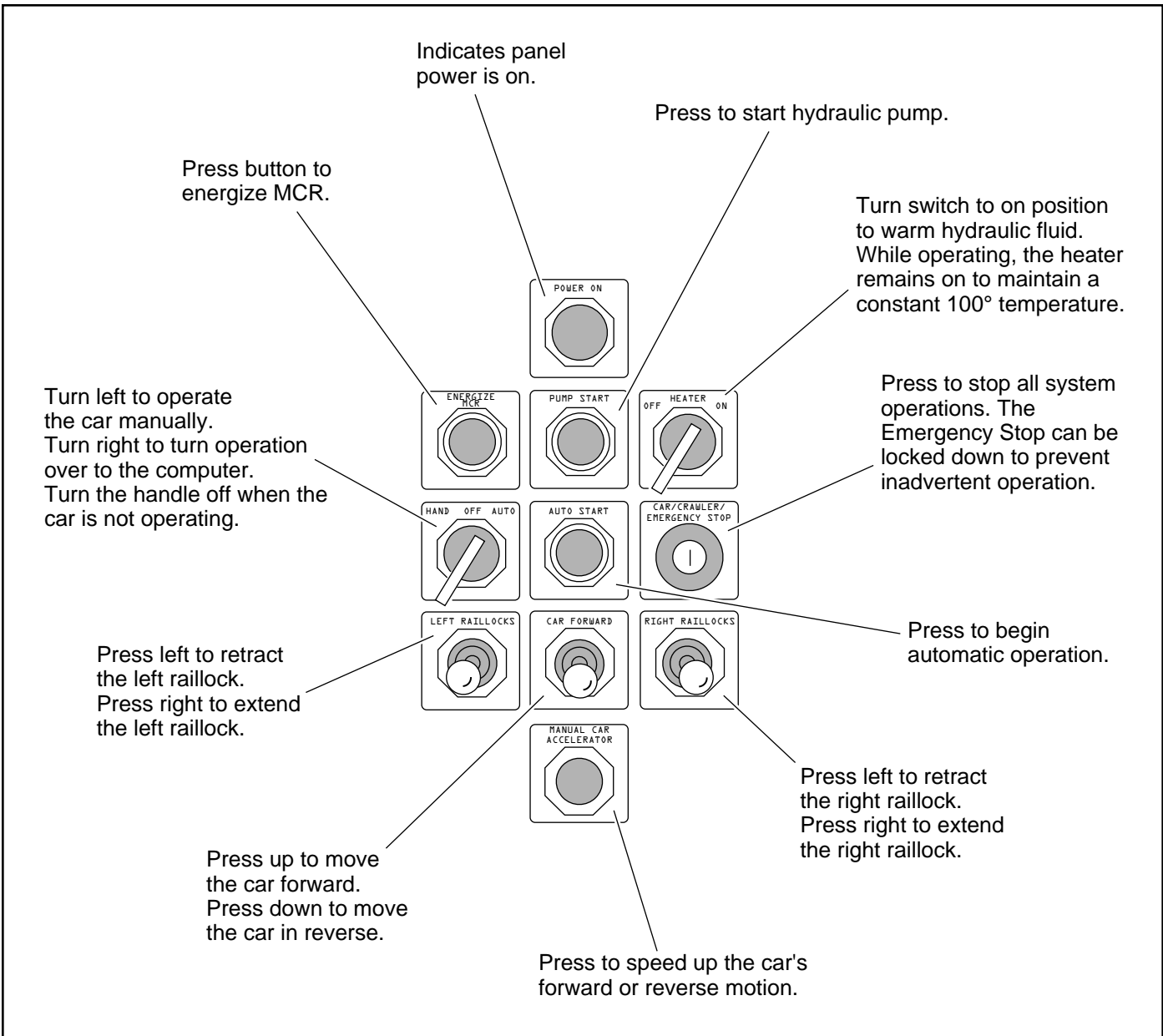

Figure 3.2 Car Manual Controls



**3.2 CAR GRAPHIC CONTROLS SCREEN**

A Small Logic Controller (SLC) located on the car control panel runs the car. Figure 3.3 calls out each of the elements in the graphic control screen.

- 3.2.1 Main Menu Screen
- 3.2.2 Car Program Screen
- 3.2.3 Crawler Fault Diagnostic Screen
- 3.2.4 Rack Shuttle Program Screen
- 3.2.5 Kiln Sequence Table Screen
- 3.2.6 Kiln Map Screen
- 3.2.7 Electrical Part Numbers Screen
- 3.2.8 Transfer Car Switch Locations Screen
- 3.2.9 Input/Output Status Screen

All computer functions are accessible from the Main Menu Screen or one of its subscreens. This section contains an illustration and function table for each screen used in operation:

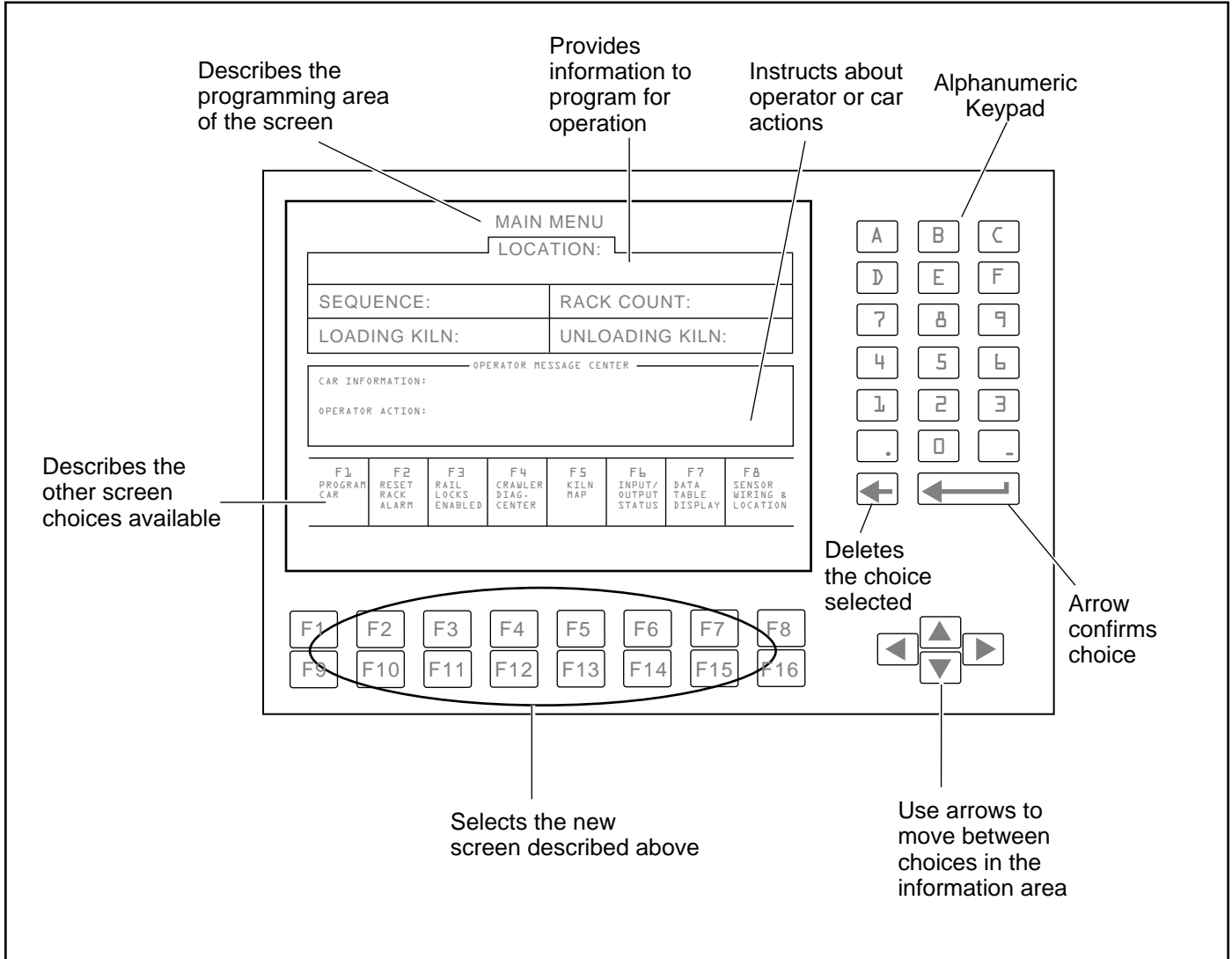

**Figure 3.3** Car Graphic Control Screen

### 3.2.1 Main Menu Screen

The Main Menu Screen gives an overview of programming options. The screen provides information about the car, such as its location, but this screen cannot program the car's action. If any of the information shown, such as Location, Sequence, Rack Count, Loading and Unloading

Kiln, is incorrect, the Main Menu Screen allows the operator access to other screens to modify the choices or correct a problem. Press the function key and the corresponding screen will appear. Make changes on that screen and then return to the Main Menu when completed.

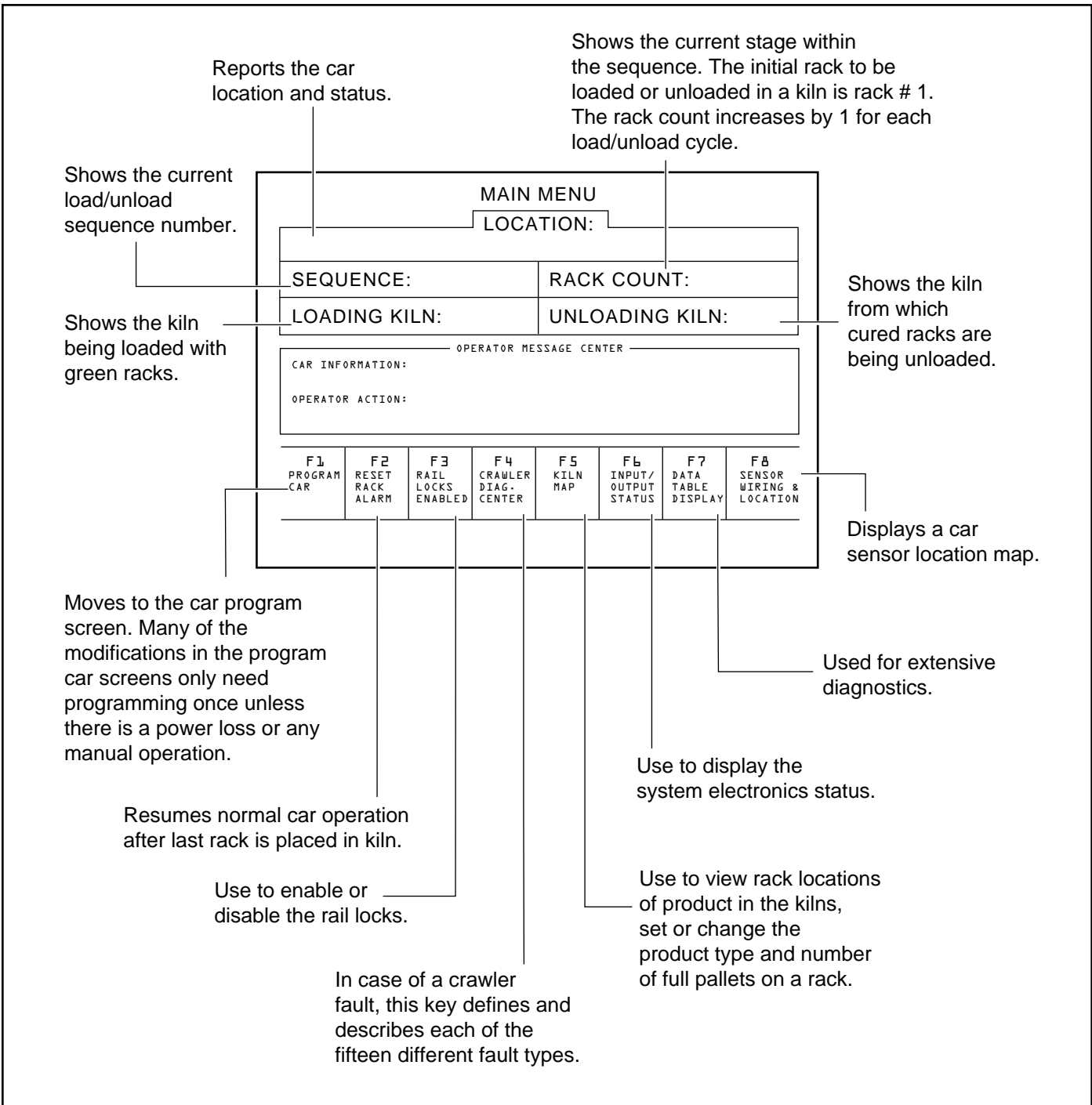
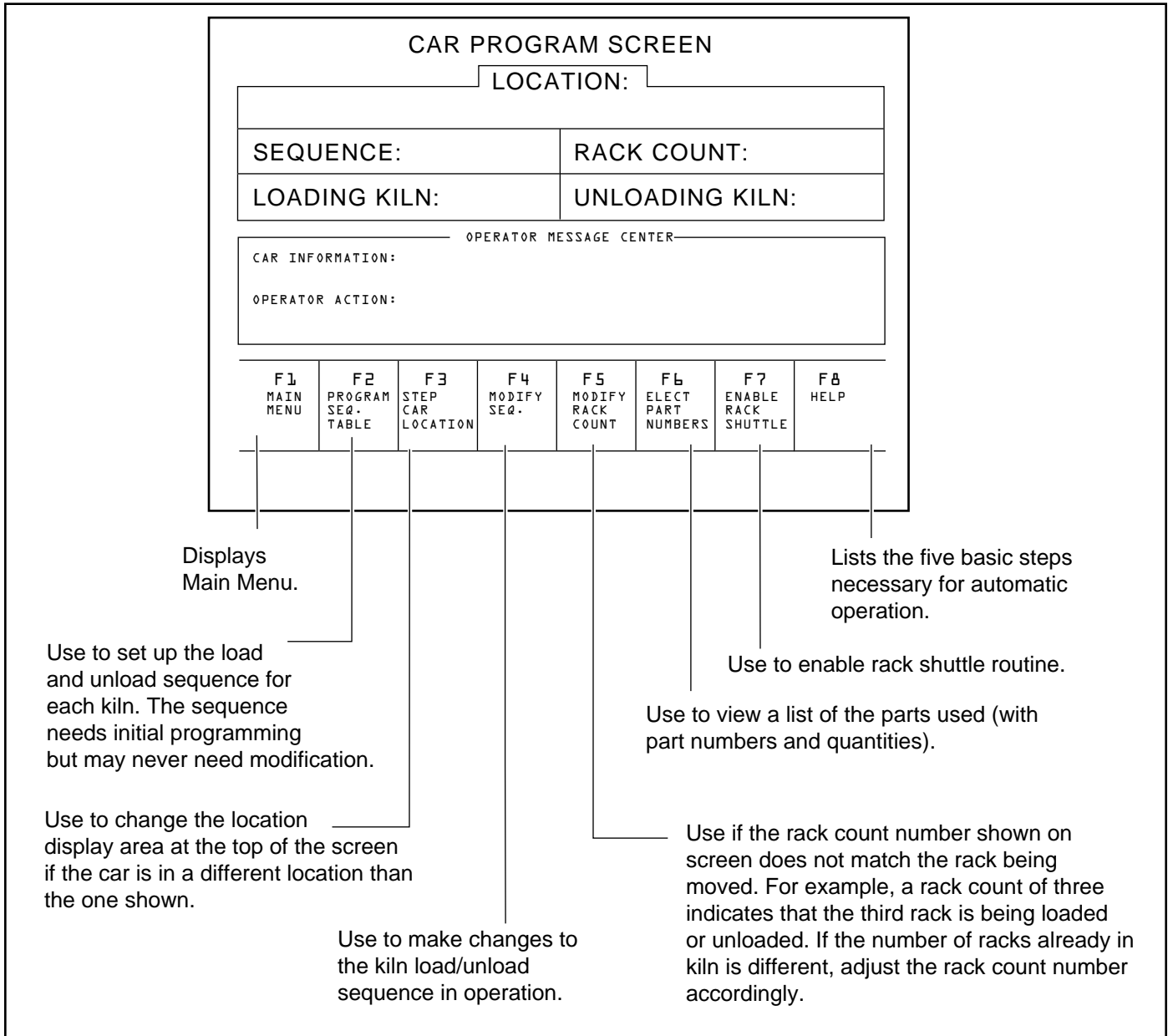

Figure 3.4 Main Menu Screen

**3.2.2 Car Program Screen**

The Car Program Screen programs and modifies the actions of the car. In the Operator Message Center, "LSC car informs" tells the operator what the car is doing. If a problem occurs, "operator action" will instruct the appropriate response needed. Press the corresponding function key to program. The cursor will appear and

the choice may be altered by using the arrows and keys on the alphanumeric keyboard. After reaching the desired setting, press enter to register the change on all screens. If the operator needs more information prior to altering a selection, return to the Main Menu and select the corresponding screen.



**Figure 3.5 Car Program Screen**

### 3.2.3 Crawler Fault Diagnostic Screen

The Crawler Fault Diagnostic Screen identifies the problems indicated on the crawler by the combination of flashing lamps. The four lamps are numbered 1, 2, 3 and 4. Once the combination is identified, find the combination in the list and identify the correct fault number. Use the function key to change the crawler fault number indicated. The

choice may be altered by using the numeric keyboard. Press F8 to view fault screen. Along with the fault number, each fault screen displays the name of the suspected device, the I/O number, and operator action.

CRAWLER FAULT DIAGNOSTIC SCREEN						
... FAULT 1	LAMPS 1+3.... FAULT 6	LAMPS 1+2+3... FAULT 11				
... FAULT 2	LAMPS 1+4.... FAULT 7	LAMPS 1+2+4... FAULT 12				
... FAULT 3	LAMPS 2+3.... FAULT 8	LAMPS 1+3+4... FAULT 13				
... FAULT 4	LAMPS 2+4.... FAULT 9	LAMPS 2+3+4... FAULT 14				
... FAULT 5	LAMPS 3+4.... FAULT 10	LAMPS 1+2+3+4FAULT 15				
<b>ENTER CRAWLER FAULT NUMBER: -</b>						
OPERATOR MESSAGE CENTER						
INFORMS: DEVICE: ERROR: REASONS: ACTION:						
F2	F3	F4	F5	F6	F7 CRAWLER SENSOR LOCATIONS	F8 CHANGE FAULT CODE

displays Menu.

Use to view a different fault code and operator action.

Displays physical location of crawler sensors.

**Figure 3.6** Crawler Fault Diagnostic Screen

**CRAWLER FAULT DIAGNOSTICS**

Fault	Lamps				Crawler Informs	Suspect Device	I / O No.	Wire No.	Operator Action
	1	2	3	4					
1	•				Oil level low fault	Float switch	I:1/14	2, 16	Add oil until correct level is obtained.
2		•			Kickbar is tripped	LS-1, LS-2	I:1/13	6, 5, 2	Check for mechanical binding or switch adjustment/failure.
3			•		Cable reel under speed fault	PRS-14	I:1/3	2,12	Check for mechanical binding or switch adjustment/failure.
4				•	Elevator position error	PRS-3A, PRS-3B	I:0/3, I:0/4	2, 24 or 2, 23	Check elevator position or switch adjustment/failure.
5	•	•			Crawler is not off car, can't elevate	PRS-4, PRS-5 PRS-6, PRS-7	I:0/5, I:0/6, I:0/7, I:1/8	2 & 35, 34, 33, 32	Check for kiln full of racks or switch adjustment/failure.
6	•		•		Raillock prox stuck on fault	PRS-4, PRS-5 PRS-6, PRS-7	I:0/5, I:0/6, I:0/7, I:1/8	2 & 35, 34, 33, 32	Retract raillocks or check raillocks proxes for fault.
7	•			•	Only one raillock was detected	PRS-4, PRS-5 PRS-6, PRS-7	I:0/5, I:0/6, I:0/7, I:1/8	2 & 35, 34 33, 32	Check switch adjustment or switch failure.
8		•	•		Elevator up fault	PRS-3B, 11CB & elevator up solenoid	I:0/4, 0:2/0	2 & 23 or 57 & 7	Check for mechanical binding or switch adjustment/failure.
9		•		•	Elevator down fault	PRS-3A, 12CB or elevator down solenoid	I:0/3, 0:2/1	2 & 24 or 46 & 7	Check for mechanical binding or switch adjustment/failure.
10			•	•	Decel & stop look-down prox stuck on fault	PRS-8, PRS-9 PRS-10, PRS-11	I:0/9, I:0/10, I:0/11, I:1/0	2 & 27 28, 25, 26	Check for switch failure.
11	•	•	•		Look up prox switch stuck on fault	PRS-15 thru PRS-23	Consult wiring diagram	Consult wiring diagram	Check each prox switch for failure.
12	•	•		•	Forward lookup prox fault	PRS-20 thru PRS-23	I:1/8, I:1/9 I:1/10, I:1/11	2 & 42, 44 30, 31	Check each prox for proper operation.
13	•		•	•	Reverse lookup prox fault	PRS-15, PRS-16 PRS-18, PRS-19	I:1/4, I:1/5, I:1/6, I:1/7	2 & 37, 39, 15, 17	Check each prox switch for proper operation.
14		•	•	•	Reserved for future diagnostics				
15	•	•	•	•	Reserved for future diagnostics				

**Table 3.1** Crawler Fault Diagnostics

### 3.2.4 Rack Shuttle Main Menu Screen

The Rack Shuttle Main Menu Screen gives an overview of programming options. The screen provides information about the car, such as its location, but this screen cannot program the car's action. If any of the information shown, such as Location, Sequence, Rack Count, Loading and Unloading Kiln, is incorrect, the Rack Shuttle Main

Menu Screen allows the operator access to other screens to modify the choices or correct a problem. Press the function key and the corresponding screen will appear. Make changes on that screen and then return to the Rack Shuttle Main Menu when completed.

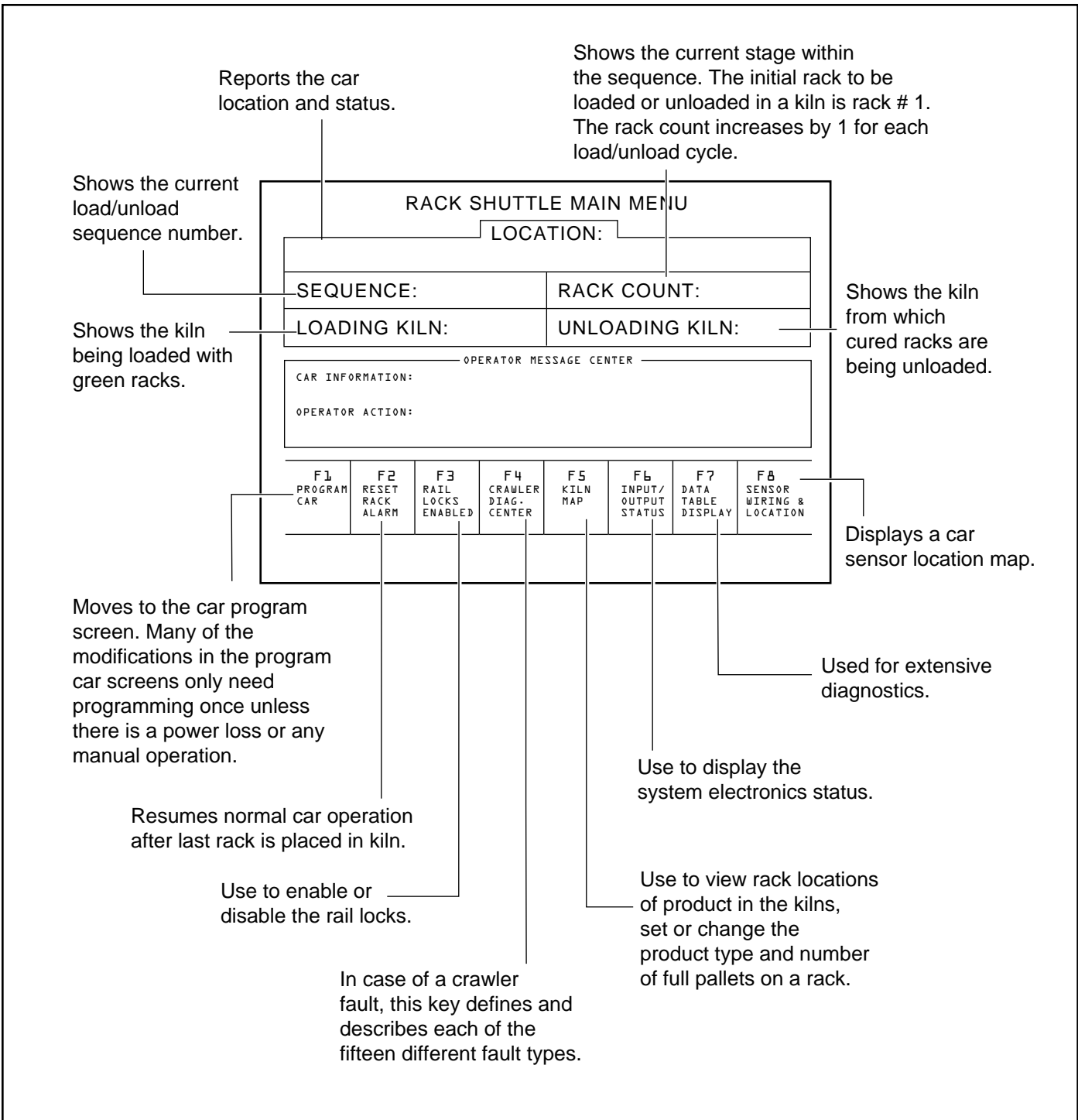
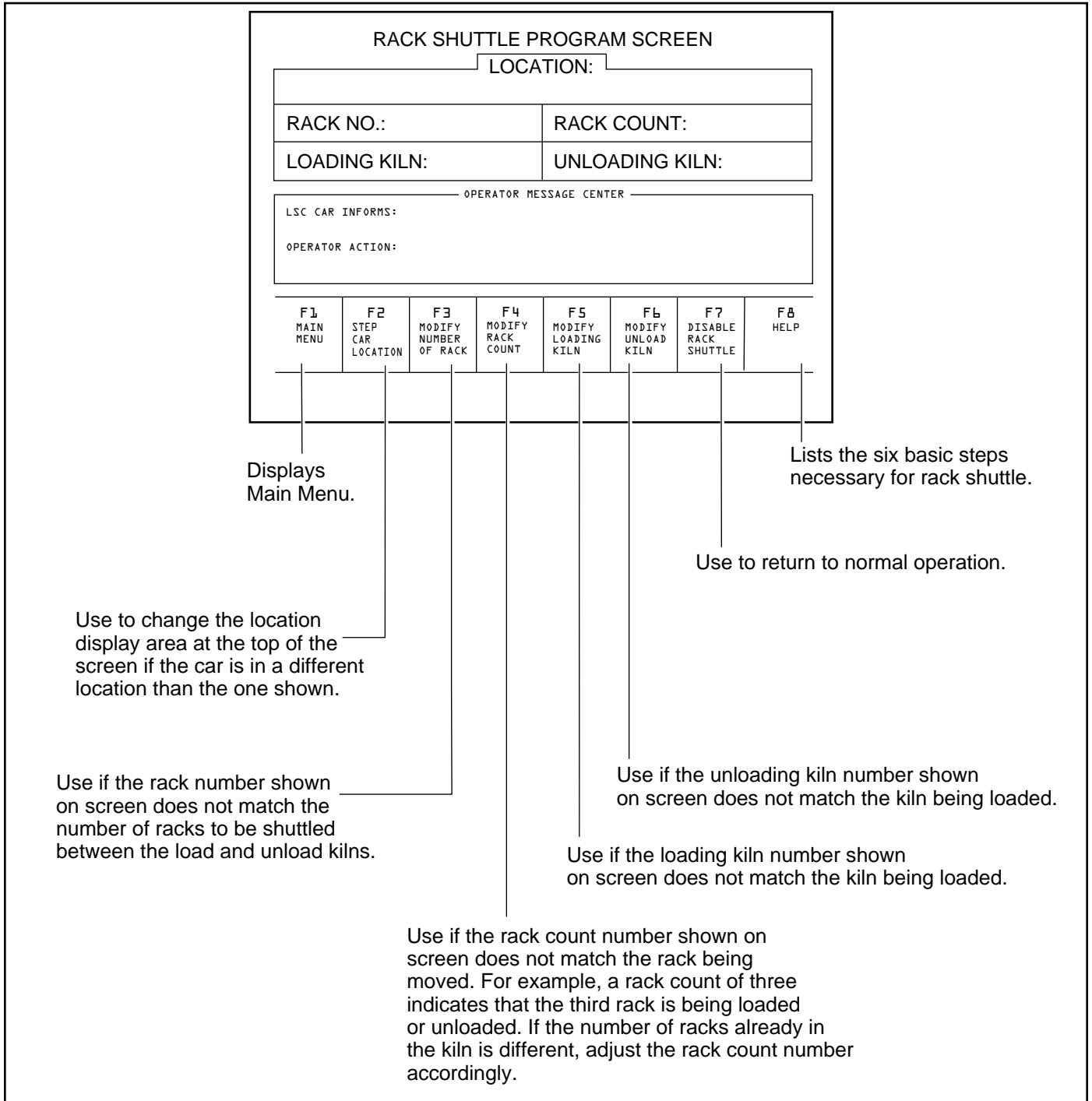

Figure 3.7 Rack Shuttle Main Menu Screen

**3.2.5 Rack Shuttle Program Screen**

The Rack Shuttle Program Screen programs and modifies the movement of racks between kilns. In the Operator Message Center, the “LSC car informs” tells the operator what the car is doing. If a problem occurs, “operator action” will instruct the appropriate response needed. Press the corresponding function key to program. The cursor will appear and the choice may be altered

by using the arrows and keys on the alphanumeric keyboard. After reaching the desired setting, press enter to register the change on all screens. If the operator needs more information prior to altering a selection, return to the Main Menu and select the corresponding screen.



**Figure 3.8** Rack Shuttle Program Screen

### 3.2.6 Kiln Sequence Table Screen

The Kiln Sequence Table programs the sequence of kiln loading and unloading. The operation cycles vary with the number of rack locations per kiln. The sequence of loading and unloading may be altered to fill or unload a certain kiln, but the Sequence Number column does not change.

When programming the sequence, keep the following in mind:

- The sequence always begins with the loading of the empty kiln.
- To repeat the sequence over from the top, enter zeros in the sequence number row at the end of the sequence.

- The load kiln number for any sequence should be the same as the unload kiln number of the previous sequence number row.

Press the function key to modify the sequence. The cursor appears on the left side when the modification mode is active. Modify the number to the right of the cursor or use the arrow keys to move the box to another row or column for modification. Press enter when complete. The new sequence will register on all screens.

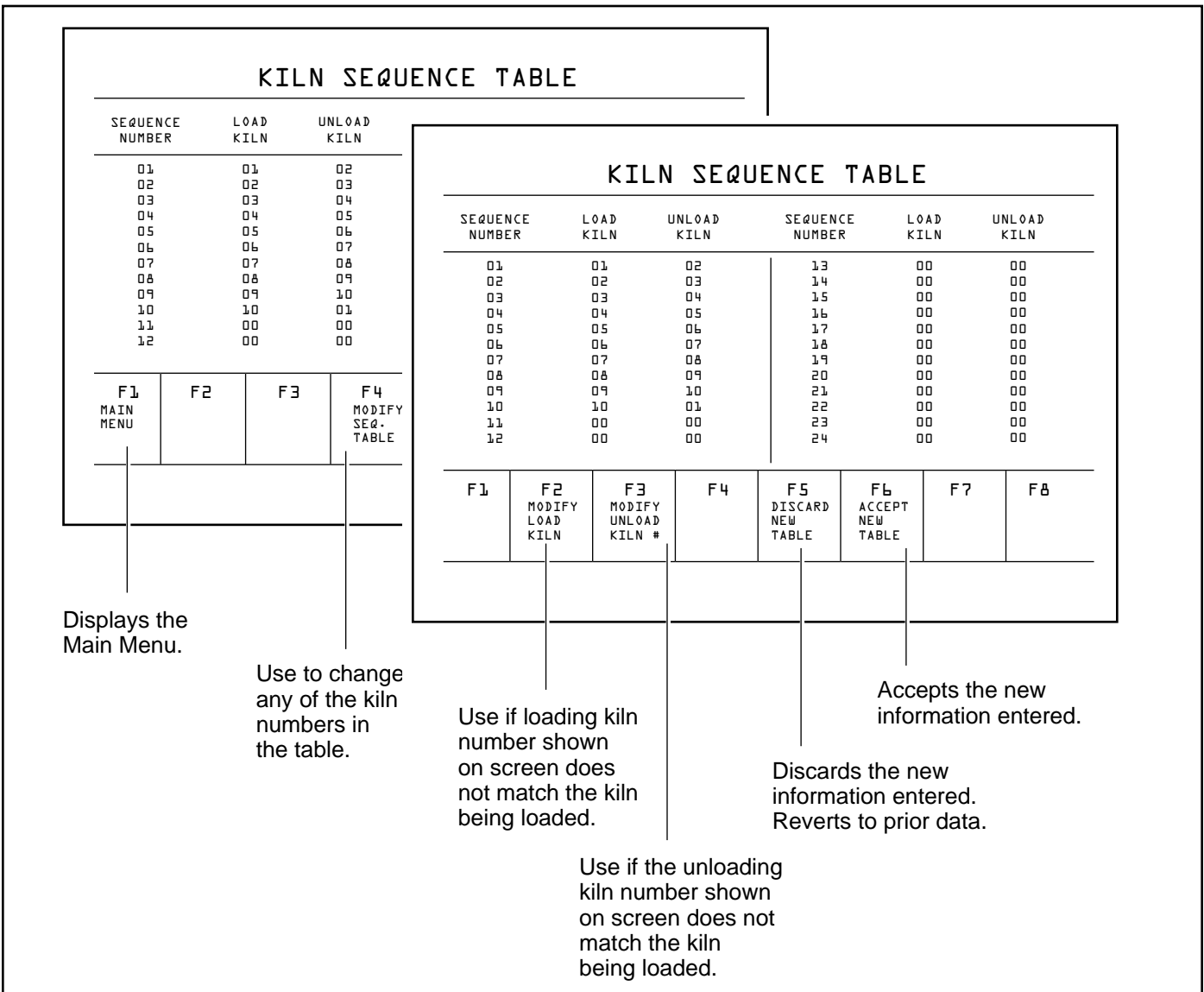

**Figure 3.9** Kiln Sequence Table Screen



**3.2.7 Kiln Map Screen**

The Kiln Map is a grid where each column represents a rack location (kiln depth) and each row represents a kiln number (kiln). For each product type used in operation, the operator may edit the product number code and the number of pallets. Both of these operations may also be controlled by a plant integration package.

To modify the kiln map:

1. Press F2. Enter the kiln number.
2. Press F3. Enter the kiln depth. A flashing green arrow appears. To modify or add a rack, press F5. To delete a rack, press F7.
3. Press F1 when information is correct.

To modify the product number:

1. Press F4 and the cursor will appear in the upper left corner.
2. Enter the appropriate product number (0-999) and pallet number (0-999).

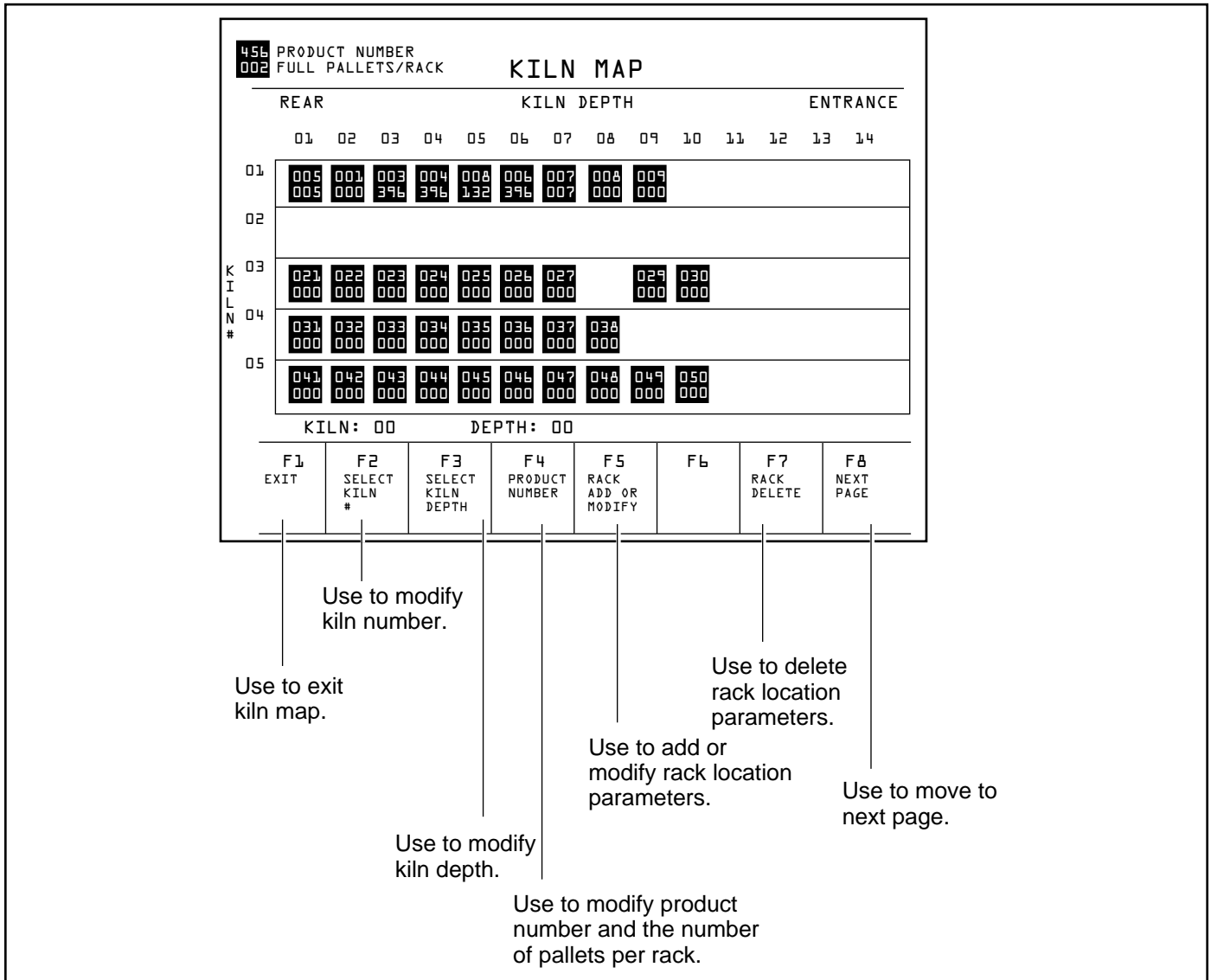

Figure 3.10 Kiln Map Screen

**3.2.8 Electrical Part Numbers Screen**

The Electrical Part Numbers for replacement are listed here to simplify ordering.

ELECTRICAL PART NUMBERS							
QTY	PART #	DESCRIPTION					
1	114763	MAN MACHINE INTERFACE					
1	113773FL524	PROCESSOR					
1	113772F00A7	RACK					
1	113772F00P2	POWER SUPPLY					
2	113772FIA16	INPUT MODULE					
2	113772F00A8	OUTPUT MODULE					
13	113118F0012	1.2 AMP CIRCUIT BREAKERS - OUTPUT MODULE					
1	112974F1030	3.0 AMP FUSE - POWER SUPPLY					
1	112974F0015	1.5 AMP FUSE - MAN MACHINE INTERFACE					
1	113773F00M2	EEPROM MODULE FOR PROCESSOR					
1	113773F00BA	LITHIUM BATTERY FOR PROCESSOR					
1	113115F0003	4 POLE RELAY					
F1 MAIN MENU	F2	F3	F4	F5	F6	F7	F8

Displays  
Main Menu.

**Figure 3.11** Electrical Part Numbers Screen

**3.2.9 Transfer Car Switch Locations Screen**

The Transfer Car Switch Locations Screen shows switch problems. When a switch faults, this switch flashes on this screen.

The Operator Message Center displays information about the faults along with the appropriate action required by the operator.

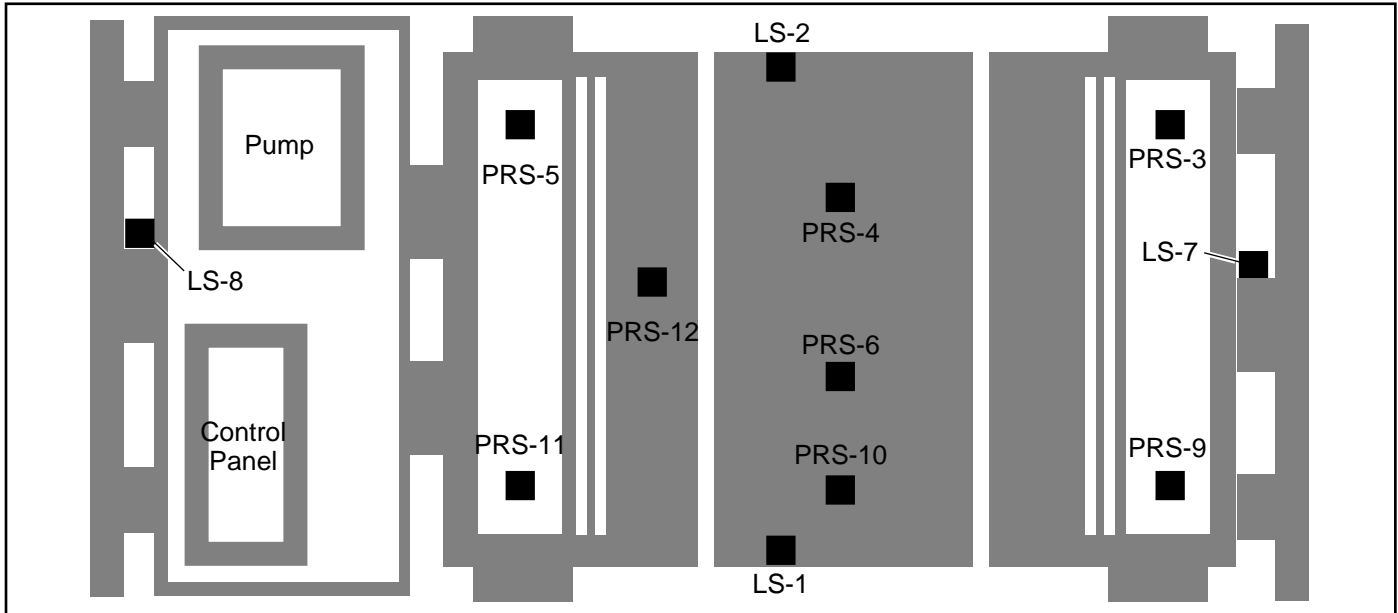

**Figure 3.12** Transfer Car Switch Locations Screen

**TRANSFER CAR FAULT DIAGNOSTICS**

Fault	Car Information	Suspect Sensor	Affected Input	Wire No.	Operator Action
1	LS-7 on the kickbar is not tripped.	LS-7	I:2/3	11, 13	Check for mechanical binding or switch adjustment/failure.
2	LS-8 on the kickbar is not tripped.	LS-8	I:2/4	11, 12	Check for mechanical binding or switch adjustment/failure.
3	The car is not centered on the actuator in front of station.	PRS-4	I:1/5	2, 41	Place car on actuator or check PRS-4 adjustment/failure.
4	The car is not centered on the actuator in front of station.	PRS-10	I:1/9	2, 38	Place car on actuator or check PRS-10 adjustment/failure.
5	The left raillock must be retracted before car movement.	LS-2	I:1/3	2, 34, 35	Check for mechanical binding or switch adjustment/failure.
6	The right raillock must be retracted before car movement.	LS-1	I:1/2	2, 33, 35	Check for mechanical binding or switch adjustment/failure.

**Table 3.2** Transfer Car Fault Diagnostics

**TRANSFER CAR FAULT DIAGNOSTICS**

<b>Fault</b>	<b>Car Information</b>	<b>Suspect Sensor</b>	<b>Affected Input</b>	<b>Wire No.</b>	<b>Operator Action</b>
7	PRS-5 missed a count.	PRS-5	I:1/6	2, 40	Check PRS-5: adjustment, wiring or failure.
8	PRS-4 missed a count.	PRS-4	I:1/5	2, 41	Check PRS-4: adjustment, wiring or failure.
9	PRS-3 missed a count.	PRS-3	I:1/4	2, 42	Check PRS-3: adjustment, wiring or failure.
10	PRS-11 missed a count.	PRS-11	I:1/10	2, 37	Check PRS-11: adjustment, wiring or failure.
11	PRS-10 missed a count.	PRS-10	I:1/9	2, 38	Check PRS-10: adjustment, wiring or failure.
12	PRS-9 missed a count.	PRS-9	I:1/8	2, 39	Check PRS-9: adjustment, wiring or failure.
13	Crawler is not on home switch.	PRS-6	I:1/7	2, 36	Check PRS-6: adjustment, wiring or failure.
14	The car is not on the actuator in front of station.	PRS-4 and PRS-10	I:1/5, I:1/9	2, 41 or 2, 38	Adjust car speed or check PRS-4 and PRS-10 adjustment/failure.
15	The crawler has left the car and has not returned.	PRS-6	I:1/7	2, 36	Check PRS-6: adjustment, wiring or sensor failure.
16	Right raillock extend fault.	LS-1	I:1/2	2, 33	Check LS-1, 14CB tripped or right raillock extend solenoid.
17	Right raillock retract fault.	LS-1	I:1/2	2, 33	Check LS-1, 13CB tripped or right raillock retract solenoid.
18	Left raillock extend fault.	LS-2	I:1/3	2, 35	Check LS-2, 6CB tripped or left raillock extend solenoid.
19	Left raillock retract fault.	LS-2	I:1/3	2, 35	Check LS-2, 5CB tripped or left raillock retract solenoid.
20	The crawler has failed to leave the car.	PRS-6	I:1/7	2, 36	Ensure crawler in auto, check raillock for binding, or PRS-6.
21	The car has encountered an unexpected door location.	PRS-12	I:2/9	2, 76	Check that the kiln door is open, or PRS-12.

**Table 3.2** Transfer Car Fault Diagnostics

**3.2.10 Input/Output Status Screen**

The Input/Output Status Screen shows the current status and provides a description of each signal.

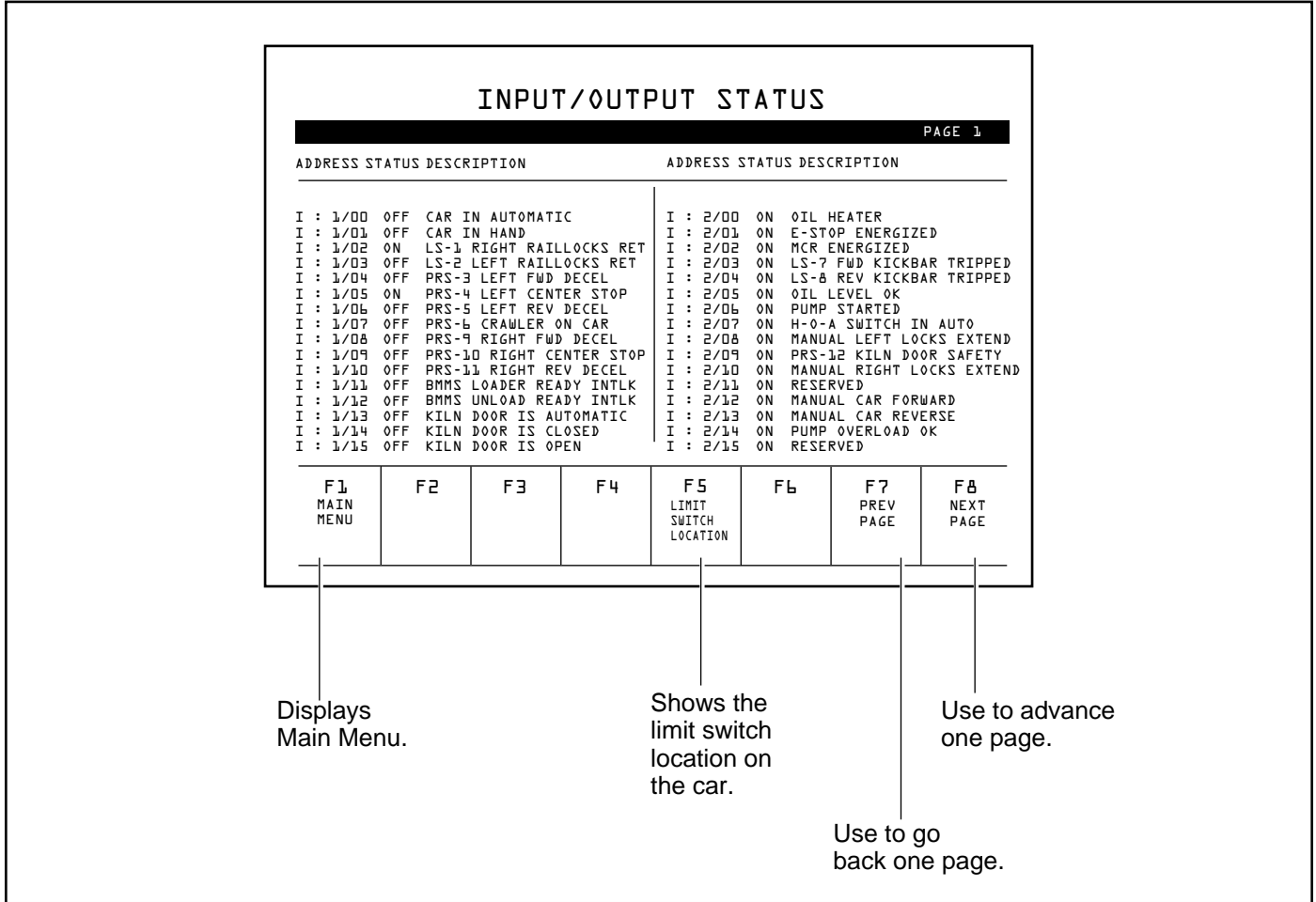

**Figure 3.13 Input/Output Status Screen**

### 3.3 SENSOR TYPES

Sensors located on the car monitor, report and control all system operations. Sensors are also essential to the car safety protection system.

There are two types of sensors:

- Limit switches (LS) are spring-loaded electromechanical devices that break a circuit based on mechanical actions.
- Proximity sensors (PRS) monitor a magnetic field to signal various operating conditions. The face of the PRS must be within 1/4 inch [6 mm] of the actuator for the sensor to activate.

### 3.4 SAFETY BARS

Safety bars protect plant personnel and equipment from inadvertent contact with the car. Safety bars are located on the leading sides of the car. When a safety bar meets any obstacle, a fail-safe limit switch (LS-7 or LS-8) signals the control system to immediately:

- Stop car movement
- Stop the car hydraulic pump

There is one LS for each safety bar. Each LS provides independent safety signals to the car control panel.

### 3.5 CAR SENSORS

This section covers the function of the following car sensors:

- 3.5.1 Motion Control Sensors
- 3.5.2 Crawler Location Sensor
- 3.5.3 Raillock Position

Figure 3.14 shows the location of all car sensors. Table 3.3 lists all car sensors along with the corresponding function and input/output terminals.

#### 3.5.1 Motion Control Sensors

PRS-3, 4, 5, 9, 10 and 11 are “look-down” sensors installed on the car frame. If an LSC-40C installation has kilns on both sides of the car rail, all six sensors are installed and active as shown in Figure 3.14. If an installation has kilns on only one side of the car rails, sensors will be installed and active on that side only.

Floor-mounted actuators are positioned on the centerline of each set of crawler rails. A PRS triggers when it comes within 1/4 inch [6 mm] of an actuator. The leading sensor signals the car to change to slow speed. The center sensor signals the car to stop.

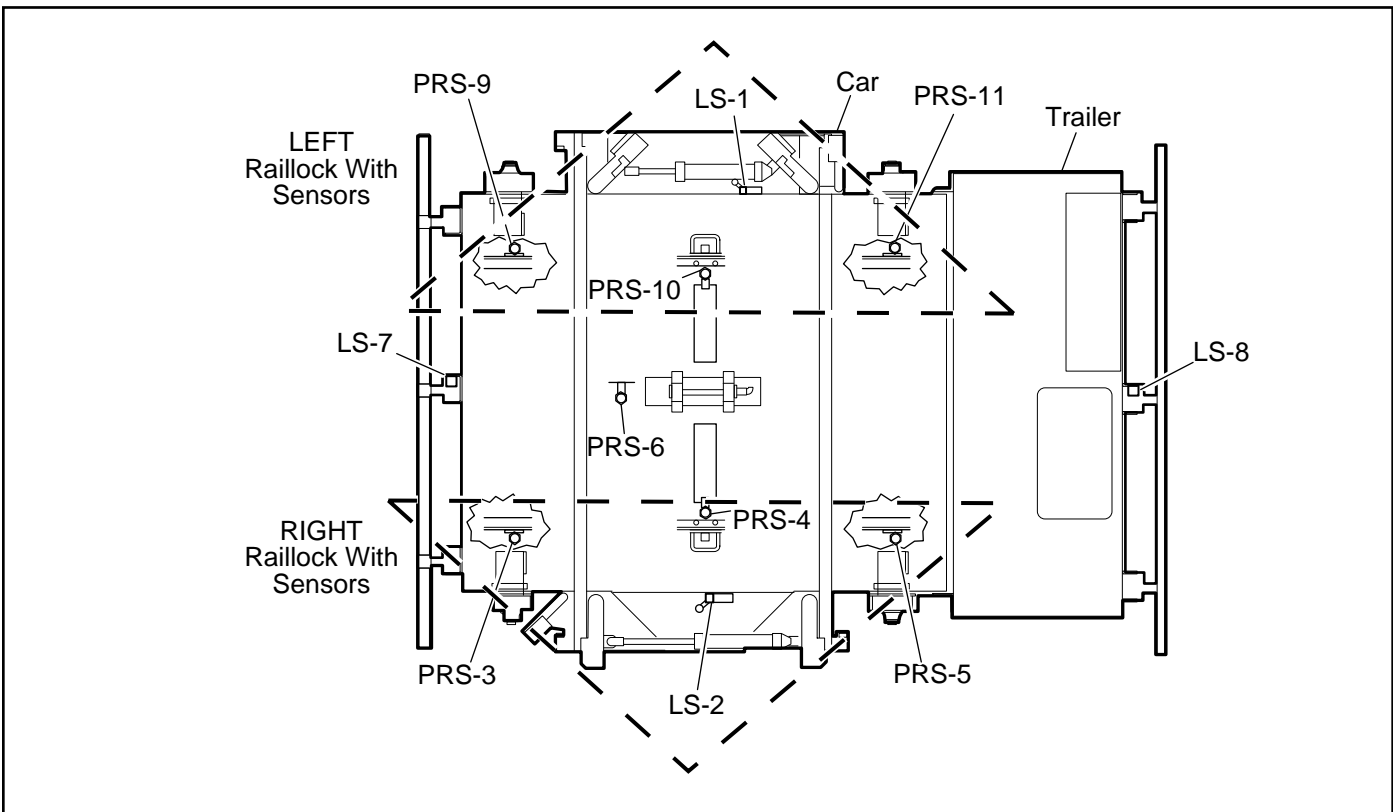

Figure 3.14 Car Sensor Locations

**CAR SENSORS**

Sensor	Function	Input/Output	
		Module	Terminal
LS-1	Right Raillock Retracted *	I:1	2
LS-2	Left Raillock Retracted *		3
LS-7	Safety Bar Tripped	I:2	3
LS-8			4
PRS-3	Left Forward Decelerate *	I:1	4
PRS-4	Car Stop On Center - Left *		5
PRS-5	Left Reverse Decelerate *		6
PRS-6	Crawler on Car		7
PRS-9	Right Forward Decelerate *		8
PRS-10	Car Stop On Center - Right *		9
PRS-11	Right Reverse Decelerate *		10

\* If Used

**Table 3.3** Car Sensor Functions

### 3.5.2 Crawler Location Sensor

PRS-6 is a proximity switch that reports crawler location status. When the crawler is on the car, PRS-6 is triggered and signals to the control system that the crawler is in position. When the crawler moves out of position, off the car, PRS-6 is released and reports this status to the car control system. A broken or obscured sensor will cause PRS-6 to report an incorrect status.

### 3.5.3 Raillock Position

LS-1 and LS-2 are limit switches that report the position of the raillocks. If raillocks are installed on only one side of the car, only one LS will be installed and active. Figure 3.15 shows raillock operation. When the car raillocks extend, the top-of-car rails match crawler rails and the crawler can move on and off the car. When the crawler is on the car, the raillocks are retracted.

The LS signals whether the raillocks are extended or retracted. The crawler can move on and off the car only when the raillocks are extended. Car movement requires the raillocks to be retracted.

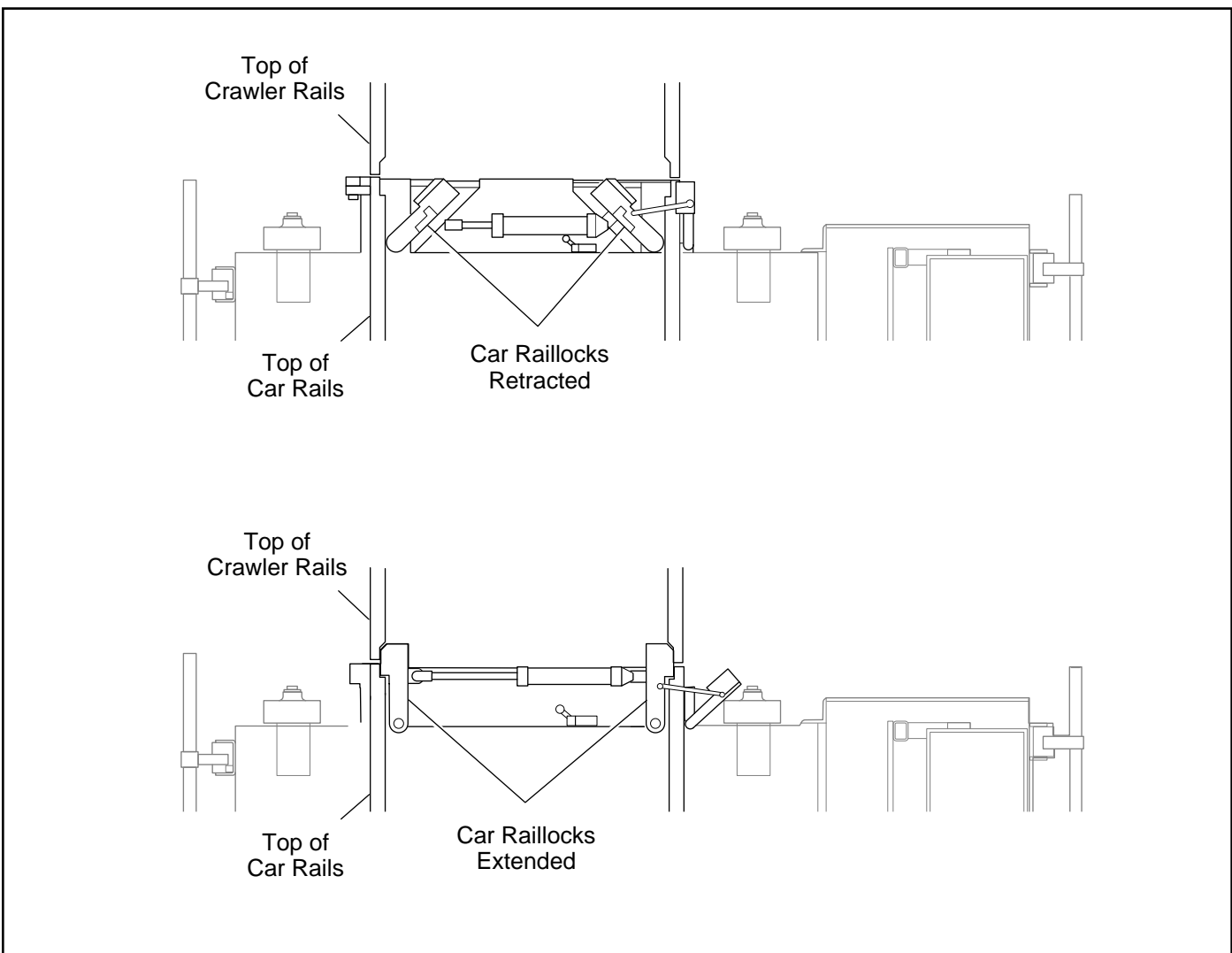

**Figure 3.15** Raillock Operation



**3.6 CAR INPUT/OUTPUT MODULES**

Figure 3.16 shows the configuration of the SLC-500 processor which is located inside the car control panel. Table 3.4 lists all car I/O signals identified by module, terminal and function.

The input module contains sixteen identical solid-state input circuits to accept the on/off status of user devices such as push buttons, limit switches and photo sensors. Each input has a red status indicator visible from the front of the module which lights when the corresponding input is turned on by an external device. If the status indicator will not light when power is applied to the input, replace the input module.

The output module contains eight identical solid-state output circuits to control the on/off status of user devices such as indicator lights or solenoids. Each output has a red load side status indicator visible from the front of the module, which lights when the corresponding output is turned on by the PLU.

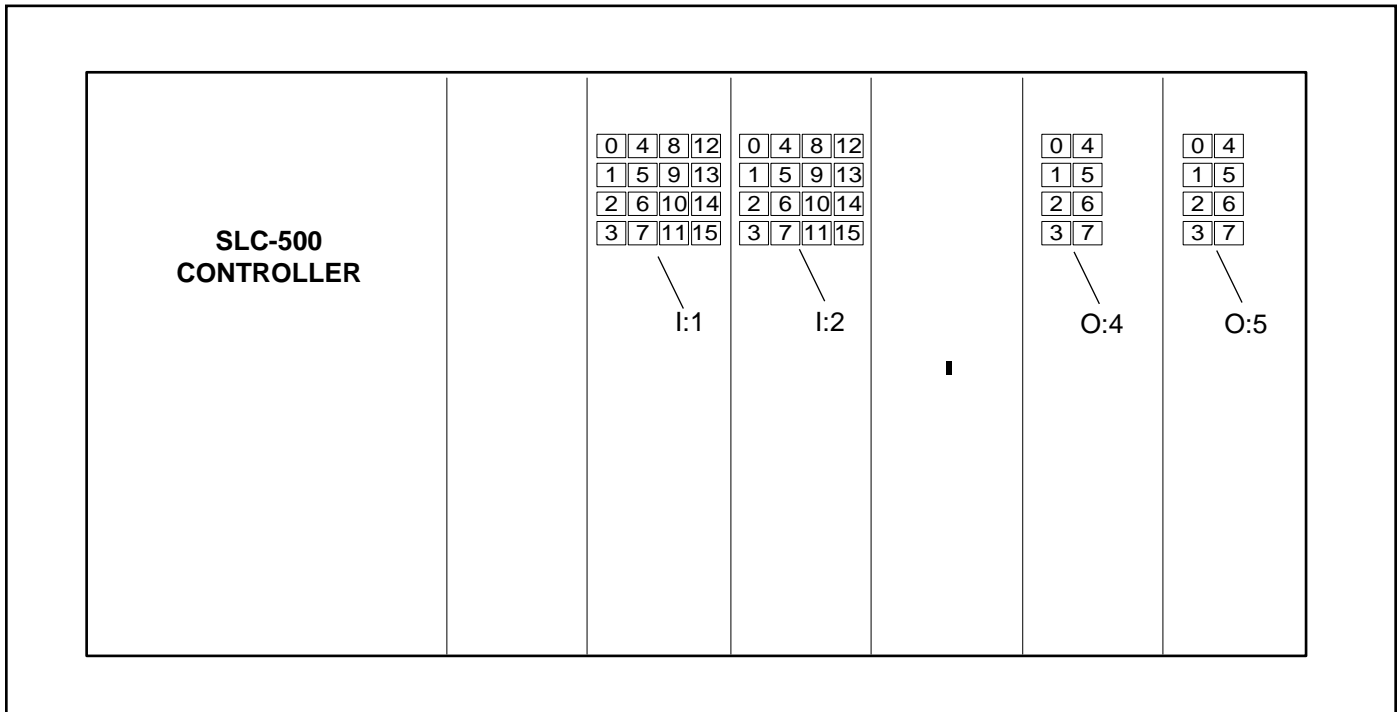

**Figure 3.16** Car Input/Output Modules

**CAR INPUT/OUTPUT SIGNALS**

Module	Terminal	Function	Sensor
I:1	0	Automatic	
	1	Hand	
	2	Right Raillock Retracted *	LS-1
	3	Left Raillock Retracted *	LS-2
	4	Left Forward Decelerate *	PRS-3
	5	Car Stop On Center - Left *	PRS-4
	6	Left Reverse Decelerate *	PRS-5
	7	Crawler On Car	PRS-6
	8	Right Forward Decelerate *	PRS-9
	9	Car Stop On Center - Right *	PRS-10
	10	Right Reverse Decelerate *	PRS-11
	11	BMMS Loader Ready	
	12	BMMS Unloader Ready	
	13	Kiln Door in Automatic *	
	14	Kiln Door is Closed *	
15	Kiln Door is Open *		
I:2	0	Heater On	
	1	Emergency Stop Energized	
	2	MCR Energized	
	3	Kickbar Tripped	LS-7
	4	Kickbar Tripped	LS-8
	5	Oil Level O.K.	
	6	Pump Started	
	7	Hand/Off/Auto in Automatic	
	8	Manual Left Raillock Extend	
	9		PRS-12
	10	Manual Right Raillock Extend	
	11		
	12	Manual Car Forward	
	13	Manual Car Reverse	
	14	Pump Overload Tripped	
15	NOT USED		
O:4	0	Unlock Left Raillock	
	1	Lock Left Raillock	
	2	Forward Slow	
	3	Forward Medium	
	4	Forward Fast	
	5	Reverse Slow	
	6	Reverse Medium	
	7	Reverse Fast	
O:5	0	Unlock Right Raillock	
	1	Lock Right Raillock	
	2	Alarm Horn	
	3		
	4	Open Kiln Door *	
	5	Close Kiln Door *	
	6	NOT USED	
*If Used	7	NOT USED	

**Table 3.4** Car Input/Output Signals

# SECTION 4

## CRAWLER CONTROL SYSTEMS

This section covers the location and operation of LSC-40C control devices.

### 4.1 CRAWLER CONTROL STATION

The crawler has two control panels that allow independent operation from either end. Both

crawler control panels consist of a button center, but only the control panel on the oil tank end has an oil heater light and a speed control center. Figure 4.1 shows the crawler control panel with the function of all manual crawler controls.

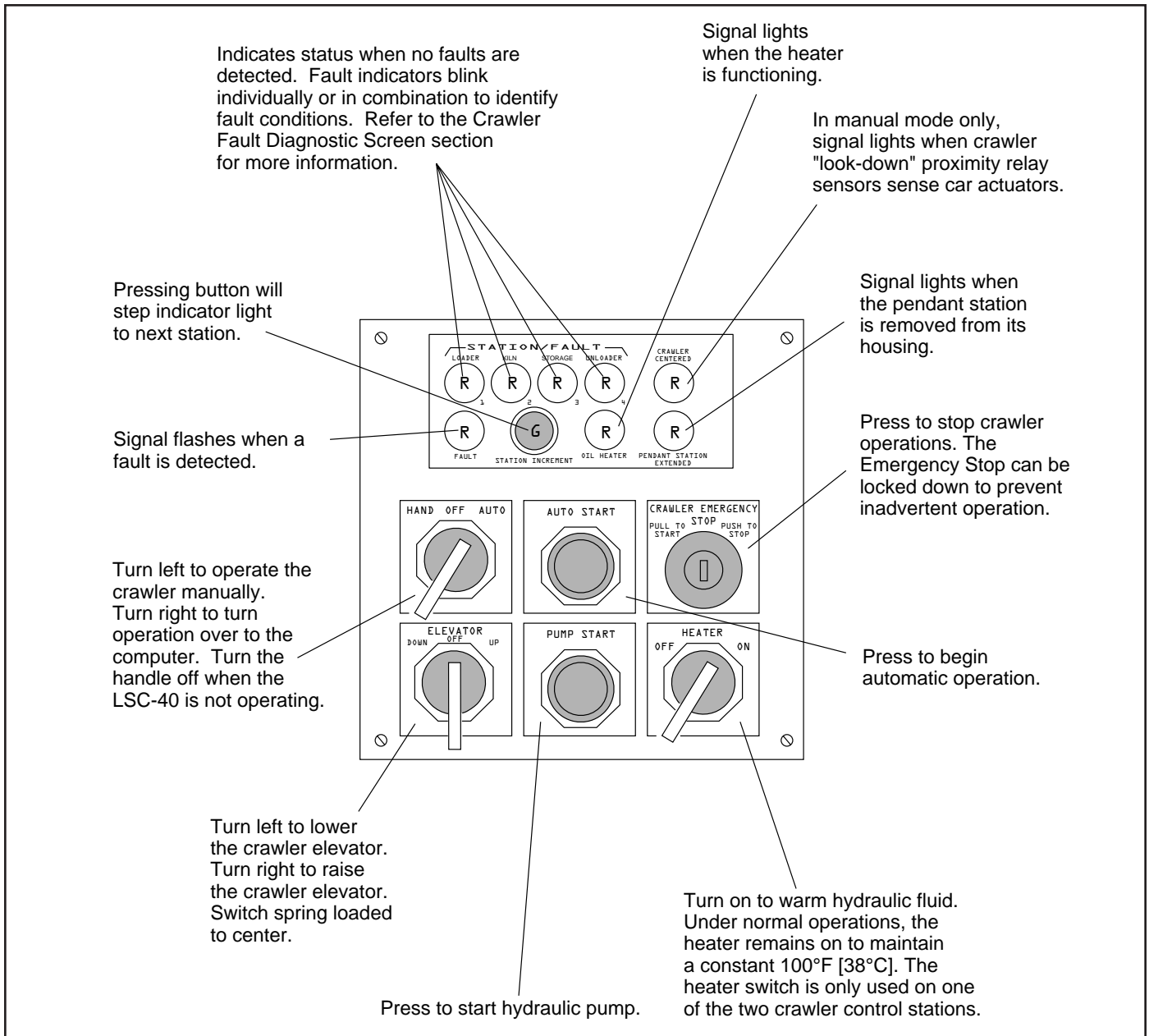

**Figure 4.1** Crawler Control Station

## 4.2 SENSOR TYPES

Sensors located on the crawler monitor, report and control all system operations. Sensors are also essential to the crawler safety protection system.

There are three types of sensors:

- Limit switches (LS) are spring-loaded electromechanical devices that break a circuit based on mechanical actions.
- Proximity sensors (PRS) monitor a magnetic field to signal various operating conditions. The face of the PRS must be within 1/4 inch [6 mm] of the actuator for the sensor to activate.
- Photo-electric sensors (PER) provide a light and reflection process as a means by which crawler movement is controlled.

Sensor function and location are covered further under the separate equipment items.

## 4.3 SAFETY BARS

Safety bars protect plant personnel and equipment from inadvertent contact with the crawler. Safety bars are located on the leading sides of the crawler. When a safety bar meets any obstacle, a fail-safe limit switch (LS-1 or LS-2) signals the control system to immediately:

- Stop car movement
- Stop crawler hydraulic pump
- Blast horn signal

There is one LS for each safety bar. Each LS provides independent safety signals to the crawler control center.

## 4.4 CRAWLER SENSORS

This section covers location and operation of the following crawler sensors:

- 4.4.1 Raillock Sensors
- 4.4.2 Motion Control Sensors
- 4.4.3 Pendant Control Station Sensors
- 4.4.4 Elevator Position Sensors
- 4.4.5 Cable Reel Sensor

Figure 4.2 shows the location and type of all crawler sensors. Table 4.1 lists all crawler sensors along with the corresponding function and input/output terminals.

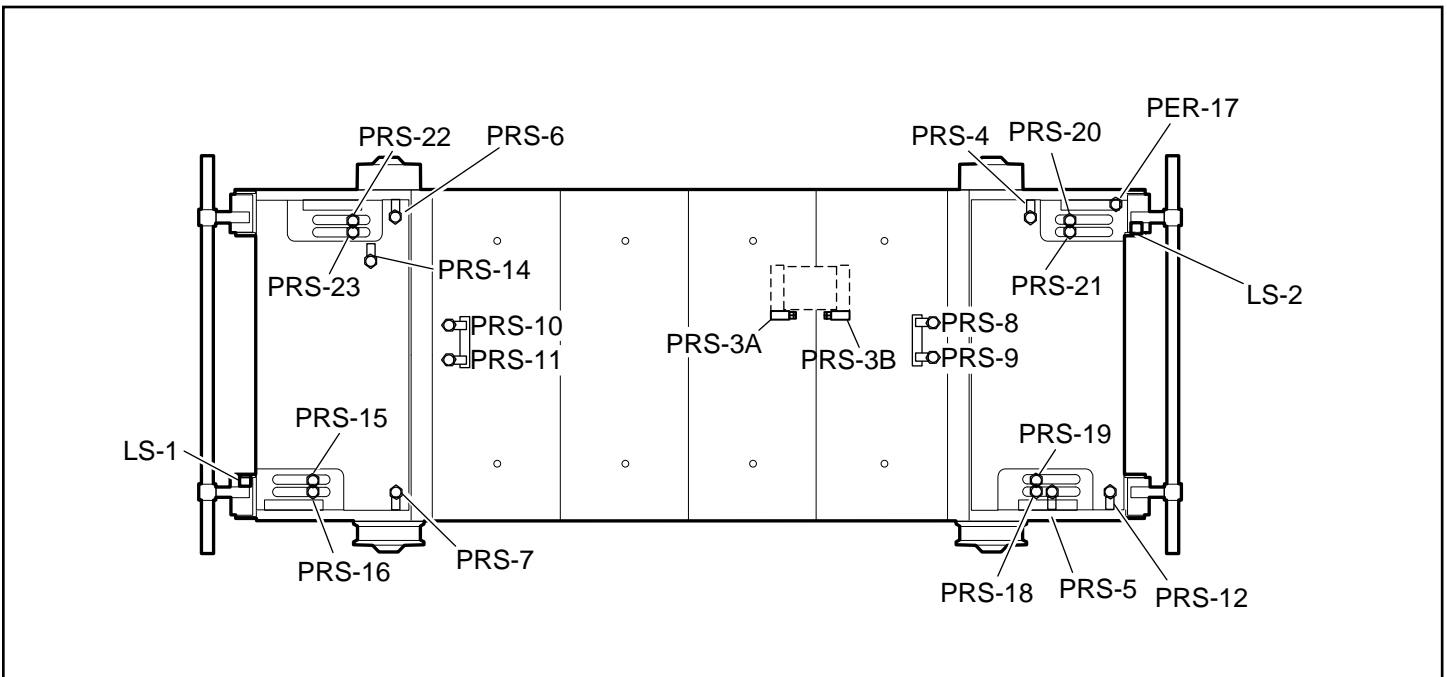

**Figure 4.2** Crawler Sensor Locations

**CRAWLER SENSORS**

Sensor	Function	Input/Output		
		Module	Terminal	
LS-1	Kickbar Safety			
LS-2	Kickbar Safety			
PER-17	Enter Side Shifter	I:1	12	
PRS-3A	Elevator Down	I:0	3	
PRS-3B	Elevator Up		4	
PRS-4	Left Front Raillock Extended		5	
PRS-5	Right Front Raillock Extended		6	
PRS-6	Left Rear Raillock Extended		7	
PRS-7	Right Rear Raillock Extended		8	
PRS-8	Forward Creep		9	
PRS-9	Forward Creep Safety		10	
PRS-10	Reverse Creep		11	
PRS-11	Reverse Creep Safety		I:1	0
PRS-12	Manual Forward			1
PRS-13	Manual Reverse	2		
PRS-14	Reel Motion Detector	3		
PRS-15*	(Used with Reverse Plant) Stops Crawler in Kiln and Decelerates Crawler in Storage	4		
PRS-16*	Safety for PRS-15	5		
PRS-18*	(Used with Reverse Plant) Stops Crawler in Storage	6		
PRS-19*	Safety for PRS-18	7		
PRS-20*	(Used with Forward Plant) Stops Crawler in Kiln and Decelerates Crawler in Storage	8		
PRS-21*	Safety for PRS-20	9		
PRS-22*	(Used with Forward Plant) Stops Crawler in Storage	10		
PRS-23*	Safety for PRS-22	11		

\*If Used

**Table 4.1** Crawler Sensor Functions

**4.4.1 Raillock Sensors**

PRS-4, 5, 6 and 7 on the crawler monitor the car raillocks.

The two PRSs on each end of the crawler correspond with the raillocks on the car. The crawler can move on and off the car only when both sensors are triggered by the extended raillocks.

**4.4.2 Motion Control Sensors**

Eight PRSs on the crawler monitor crawler motion in relation to rack position. As shown in Figure 4.2, PRS-15, 16, 18, 19, 20, 21, 22 and 23 are paired and each one of the sensors has an independent signal. As an LSC-40C fail-safe safety feature, both PRSs in the pair must report an identical signal. A fault condition occurs if the signals do not match each other.

The function of these eight sensors is controlled by system logic and depends on:

- Crawler travel direction
- Rack present on crawler

**4.4.3 Pendant Control Station Sensors**

PRS-12 and PRS-13 signal when the pendant control is removed from the holder. In this state, LSC-40C stops automatic operation and the pendant control buttons become active. When a pendant is removed, the Pendant Station Extend signal light on the crawler control panel will light.

**4.4.4 Elevator Position Sensors**

Two different sensors monitor elevator position. PRS-3A reports when the elevator is down. PRS-3B reports when the elevator is up.

**4.4.5 Cable Reel Sensors**

PRS-14 monitors cable reel motion.

**4.5 SIDE SHIFTER INTERFACE**

Emitters 101 and 102 are floor level sensors installed along the left crawler rail leading to the side shifter. These sensors receive signals from the side shifter to regulate crawler movement based on the ready state of the side shifter.

**4.6 CRAWLER INPUT/OUTPUT MODULES**

Figure 4.3 shows the configuration of the SLC-500 processor which is located under the doors on the floor of the crawler. Table 4.2 lists all crawler I/O signals identified by module, terminal, function and related sensor for I/O signals that correspond to an installed sensor.

The input module contains sixteen identical solid-state input circuits to accept the ON/OFF status of user devices such as push buttons, limit switches and photo sensors. Each input has a red status indicator visible from the front of the module which lights when the corresponding input is turned on by an external device. If the status indicator does not light when power is applied to the input, replace the input module.

The output module contains eight identical solid-state output circuits to control the ON/OFF status of user devices such as indicator lights or solenoids. Each output has a red load side status indicator visible from the front of the module which lights when the corresponding output is turned on by the CPU.

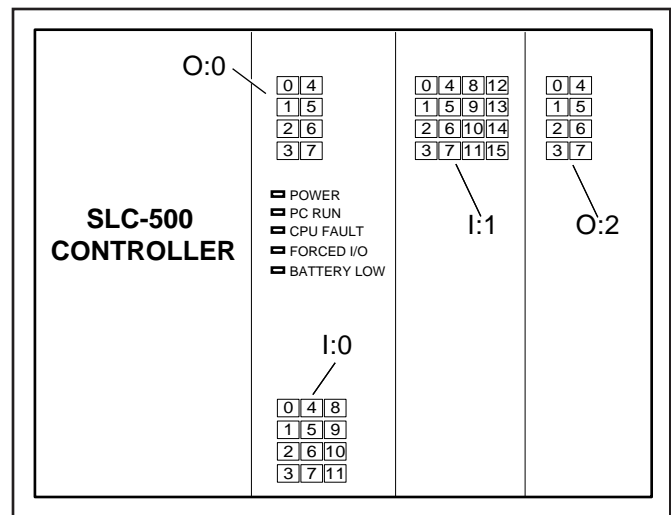

Figure 4.3 Crawler Input/Output Modules

**CRAWLER INPUT/OUTPUT SIGNALS**

Module	Terminal	Function	Sensor
I:0	0	Automatic	
	1	Hand	
	2	Station Increment	
	3	Elevator Down	PRS-3A
	4	Elevator Up	PRS-3B
	5	Left Front Raillock Extended	PRS-4
	6	Right Front Raillock Extended	PRS-5
	7	Left Rear Front Raillock Extended	PRS-6
	8	Right Rear Raillocks Extended	PRS-7
	9	Forward Creep	PRS-8
	10	Forward Creep Safety	PRS-9
	11	Reverse Creep	PRS-10
I:1	0	Reverse Creep Safety	PRS-11
	1	Manual Forward	
	2	Manual Reverse	
	3	Reel Motion Detector	PRS-14
	4	(Used With Reverse Plant) Stops Crawler in Kiln and Decelerates Crawler in Storage	PRS-15
	5	Safety for PRS-15	PRS-16
	6	(Used With Reverse Plant) Stops Crawler in Storage	PRS-18
	7	Safety for PRS-18	PRS-19
	8	(Used With Forward Plant) Stops Crawler in Kiln and Decelerates Crawler in Storage	PRS-20
	9	Safety for PRS-20	PRS-21
	10	(Used With Forward Plant) Stops Crawler in Storage	PRS-22
	11	Safety for PRS-22	PRS-23
	12	Enter Side Shifter	PER-17
	13	Kickbars Not Tripped	
	14	Oil Level Low	
	15	NOT USED	
O:0	0	Loader/Fault 1	
	1	Kiln/Fault 2	
	2	Storage/Fault 3	
	3	Unloader/Fault 4	
	4	Alarm Horn	
	5	Crawler On Center Indicator	
	6	Fault Indicator	
	7	NOT USED	
O:2	0	Elevator Up	
	1	Elevator Down	
	2	Forward Slow	
	3	Reverse Slow	
	4	Forward Medium	
	5	Reverse Medium	
	6	Forward Fast	
	7	Reverse Fast	

**Table 4.2** Crawler Input/Output Signals





# SECTION 5 MAINTENANCE



**WARNING:**

To prevent injury to personnel or damage to equipment, always follow applicable lockout/tagout procedures before servicing electrical components. Keep electrical equipment clean and dry.

### 5.1 MAINTENANCE OVERVIEW

When properly installed and operating according to Besser guidelines, the LSC-40C can be expected to deliver efficient long-term performance. In order to obtain the long-term productivity benefits that Besser designed into the LSC-40C, the customer must perform the preventive maintenance services outlined in this section within the required intervals. Of particular importance is the regular inspection and servicing of the car and crawler hydraulic systems.

This section provides guidelines for all routine system maintenance. The maintenance time table listed in Section 5.8 provides a general guide to scheduled service.

### 5.2 SENSOR MAINTENANCE

For LSC-40C operation, all sensors must be in proper position and in good working order. The fail-safe system logic will not allow equipment to move unless the sensor signals correspond with what the program expects. In the event of a sensor fault, both the car and crawler diagnostics will help identify the problem sensor. Regular sensor cleaning and inspection can be effective in preventing problems from stopping operations.

#### 5.2.1 Sensor Position

Vibration or accidental jarring could dislodge a sensor from its proper position. Figure 5.1 shows how to make vertical and horizontal adjustments of both “look-up” and “look-down” sensors.

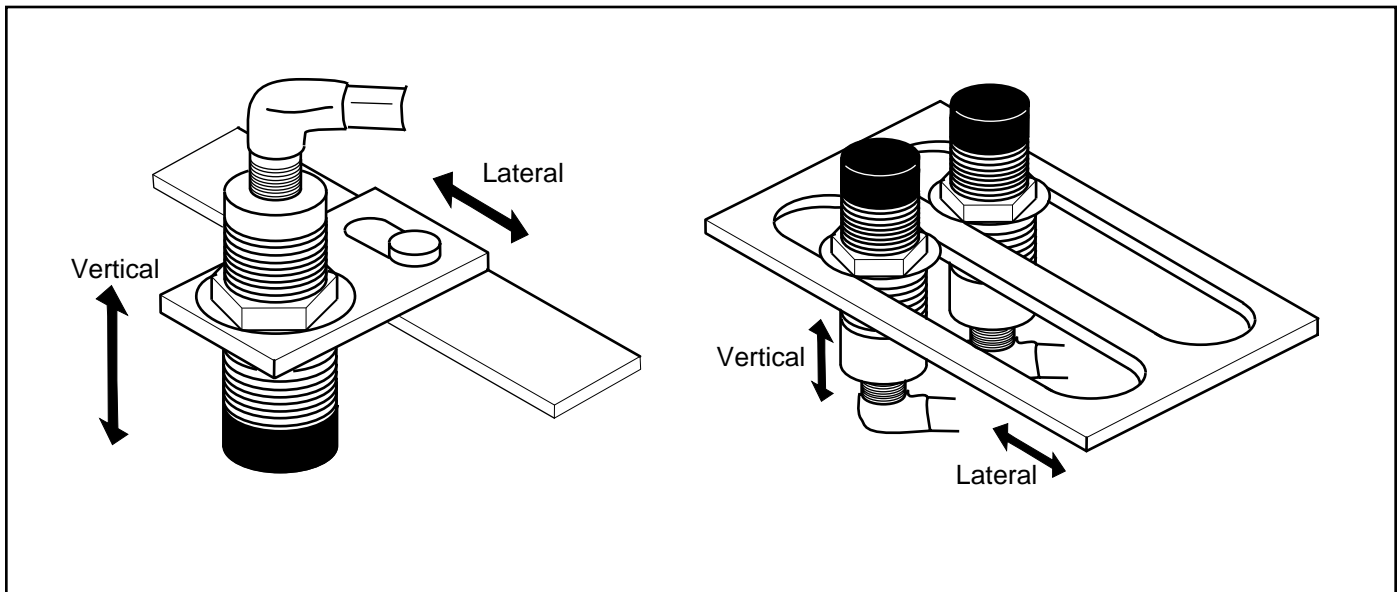

**Figure 5.1** Sensor Adjustments

### 5.2.2 Sensor Cleaning

Accumulated dust and debris on a sensor face could prevent a sensor from functioning properly. Both proximity and photo sensors need to be kept free of excessive dirt build-up.

### 5.2.3 Enter Side Shifter Emitter

PER-17 is a photo receiving relay on the crawler that requires a light beam from the emitters installed along the left crawler rail leading to the side shifter. An obscured emitter could prevent the crawler from receiving correct information from the side shifter.

## 5.3 SAFETY DEVICES

For protection of plant personnel, make sure that LSC-40C safety devices are checked regularly and maintained in good working condition. In particular, the following devices and components require regularly scheduled safety checks:

- Car safety bars
- Crawler safety bars
- Car rail safety stops
- End-of-kiln safety stops
- Auxiliary rails safety stop
- Signal light
- Signal horn

Any safety component that is not in proper working order must be repaired or replaced immediately. See the Parts List for replacement information of safety devices.

## 5.4 HYDRAULIC SYSTEMS

The car and crawler hydraulic systems are heavy duty systems that are designed to operate with minimal maintenance. However, any hydraulic fluid will break down over extended usage, particularly under extremely dusty conditions. Both car and crawler hydraulic systems are protected with an in-line filter. Regular filter inspection and replacement is essential for achieving the expected service life of hydraulic fluid.

### 5.4.1 Leakage

Leaking hydraulic fluid is never acceptable. Drips, leaks or accumulations of fluid anywhere along the equipment paths must be corrected. A fluid leak can result from various causes:

- Damaged hose
- Faulty motor
- Loose fitting
- Broken valve

To prevent further problems from occurring, determine the cause of the leak and repair immediately.

### 5.4.2 Hydraulic Fittings

#### Pipe Threads

Use the following steps to assemble the pipe threads.

#### NOTE:

Do not use teflon tape. This may damage the directional valves.

1. Assemble connection hand tight. Use Loctite® thread sealant (Besser part number 113320).
2. Mark male and female parts. See Figure 5.2.
3. Rotate male part using Table 5.1.

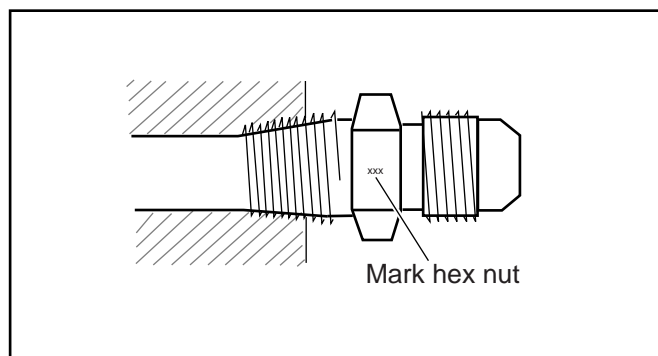

Figure 5.2 Pipe Threads

Turns from Finger Tight (TFFT) Pipe Threads – NPTF	
Fitting Size	TFFT
-2 & -4	2.0 to 3.0
-6	1.5 to 3.0
-8 & -12	2.0 to 3.0
-16 -20 -24 & -32	1.5 to 2.5

Table 5.1 Pipe Threads

**Tube Fittings**

Use the following steps for the standard SAE 37° flare type tube fitting. Use SAE J524B or SAE J525B tubing for best bending and flaring results.

**NOTE:**

Do not use pipe dope thread sealant or teflon tape.

1. Cut the tubing with a tube cutter. If a fine tooth hacksaw is used, make sure cut-off is square.
2. Remove burrs with deburring tool, emery paper or fine file. Clean all dirt and grit from the I.D. and O.D. of the tube.
3. Place the nut and then the sleeve onto tube. The threaded end of nut and flared end of sleeve must face the end of tube. See Figure 5.3.
4. Flare the tube end with a flaring tool to provide a 37° flare. Check the flare for correct diameter, excessive thin out and burrs or cracks.
5. Lubricate all mating surfaces of nut, ferrule and body with a heavy lubricant.
6. Assemble the nut and sleeve to body. Turn the nut hand tight then wrench tighten for a leakproof joint. See Table 5.2 for tightening information.

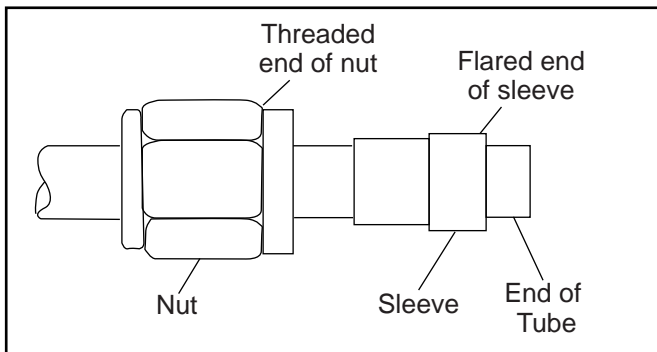

**Figure 5.3** Flare Fitting

Flats from Finger Tight (TFFT) SAE 37° Swivels	
Fitting Size	Rotation of Flats
-04 & -05	2.5
-06 -08 & -10	2
-12 -16 & -20	1
-24	.5 to .75

**Table 5.2** SAE 37° Swivels

**5.4.3 Hydraulic Filters**

Figure 5.4 shows a typical hydraulic in-line filter that is located near the oil tanks on both the car and crawler. Remove the filter canister from the stationary cap by turning the canister counter-clockwise.

During initial operation of an LSC-40C, inspect the filter weekly. Replace the filter when the pointer of the filter gage is in the “red” area. After several weeks of adjusting to plant conditions, monthly filter inspection should be adequate.

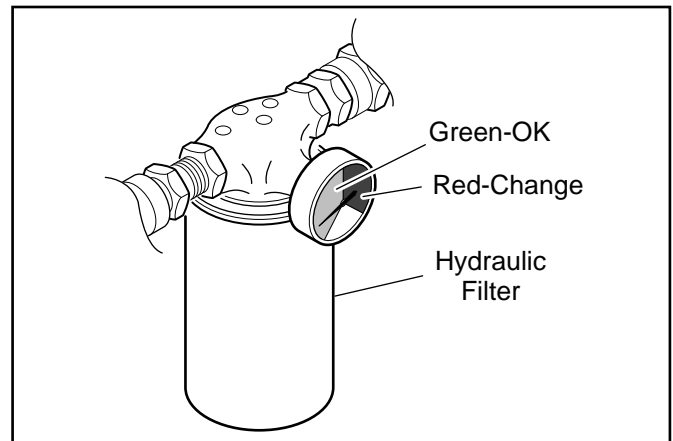

**Figure 5.4** Hydraulic Filter

#### 5.4.4 Fluid Condition

Aside from contamination, hydraulic fluid can undergo physical and chemical changes that reduce its effectiveness. Resulting problems from using decomposed fluid include:

- Accelerated pump wear
- Reduced motor power
- Slower equipment movement

Besser Company offers an inspection kit (Besser Part No. 114546) to analyze hydraulic fluid condition. The kit analyzes the last four fluid samples providing a data comparison of:

- Particle counts
- Water content
- Viscosity
- Wear metal and additive content

A diagnostic statement provides a layman explanation of the test and its results regarding the condition of the equipment and the hydraulic fluid. The information is graphed against ISO (International Standards Organization) standards to show the overall cleanliness of the system.

#### 5.5 RAILS

LSC-40C equipment is sufficiently heavy that normal levels of concrete dust should not hinder movement. As often as required by plant conditions, clean out the grooves along the car and crawler rails to prevent a build-up of debris. Also, make sure that the top surfaces of the actuators are kept clean.

#### 5.6 CABLE REEL

This section covers two cable reel service procedures:

- Cable Replacement
- Spring Replacement

The cable is subjected to surface wear and fatigue from continual unwinding and winding. There are three internal cable reel springs. A loose or floppy cable that rewinds with reduced spring tension indicates the need for spring replacement.

**5.6.1 Cable Replacement for Unmounted Reel**

Replace the working cable by removing the reel and mounting bracket assembly from the crawler and securing the assembly in a bench vise. Before disconnecting any wires, note and record wire colors, circuit numbers and terminal numbers. This precaution will help ensure accurate reconnection. See Figures 5.5 and 5.6.

To prepare the reel for new cable:

1. Shut off and lock out main system power.



**WARNING:**  
Failure to properly lockout the cable reel prior to performing maintenance may cause injury to personnel.

2. Disconnect the working cable at the car control panel.
3. Wind the old cable onto the reel and allow the reel springs to lose tension.



**CAUTION:**  
Do not allow the cable to freely rewind onto the reel. Hold the cable end as it rewinds, or control reel speed as the cable rewinds.

4. Disconnect the cable reel sensor wire from the back of the mounting bracket. Leave the sensor installed in the bracket.
5. Disconnect the crawler power wires at the crawler control panel.

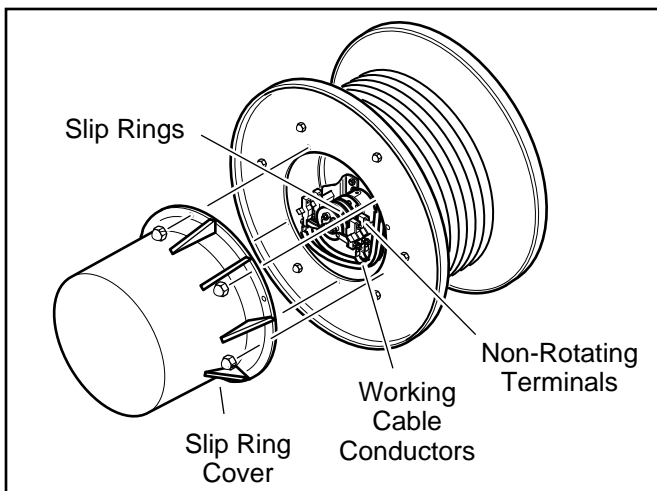
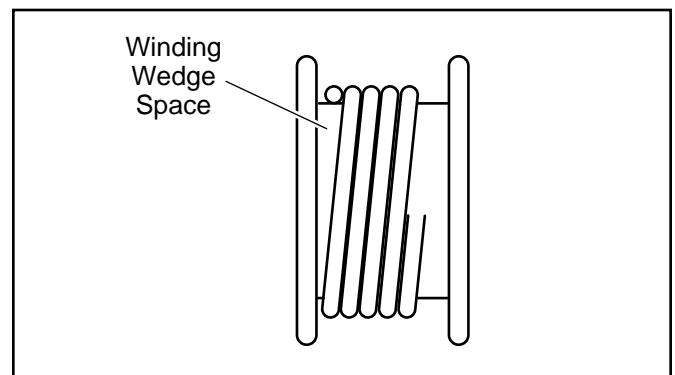

**Figure 5.5** Cable Reel Assembly

6. Remove the reel from the crawler by unbolting the mounting bracket from the base of the crawler. Secure the reel and bracket assembly in a bench vise.
7. Remove the slip ring cover and disconnect the working cable conductors from the non-rotating terminals.
8. Remove the old working cable from the reel by pulling it sideways off the reel. Make sure that the removal process does not tension the spring.
9. Loosen the tension relief clamp and pull the end of the old cable out of the cable entrance.

To install the new cable:

1. Place the storage reel with the new working cable on its side and unroll the new cable in a straight line. Straighten any twists in the working cable before winding the cable on the reel.
2. Thread the new working cable through the cable entrance on the reel.
3. Tighten the tension relief clamp.
4. Install terminals on the ends of the working cable conductors. Reconnect the working cable conductors to the non-rotating terminals.
5. Begin winding the new working cable onto the reel.
6. After winding the new cable, tape or tie down the loose cable end to keep it from interfering with reel installation.
7. Install the reel in the crawler and reconnect the crawler power wires at the crawler control panel.



**Figure 5.6** Cable Winding

To complete cable installation:

1. Pre-tension the cable reel spring by turning the reel seven times in direction of arrow.
2. Pull cable off reel from underside and route cable through crawler guide rollers.
3. Feed cable through pivot fitting on car and into the car control panel.
4. Make terminal connections inside car junction box.
5. Restore system power.

### 5.6.2 Spring Replacement

See Figure 5.7. There are three internal cable reel springs. If one spring breaks, the working cable will rewind slowly with reduced tension or may not rewind fully. In case of a single broken spring, it is important to replace all springs. The unbroken spring is likely to be operating at reduced efficiency and could also be close to failure. To prepare the reel for new springs:

1. Shut off and lock out main system power.



**WARNING:**

Failure to properly lock out the cable reel prior to performing maintenance may cause injury to personnel.

2. Disconnect the working cable at the car control panel.
3. Wind the cable onto the reel and allow the reel springs to lose tension.



**CAUTION:**

Do not allow the cable to freely rewind onto the reel. Hold the cable end as it rewinds, or control reel speed as the cable rewinds.

4. Disconnect the crawler power wires at the crawler control panel.
5. Disconnect the cable reel sensor wire.
6. Remove the reel from the crawler housing.

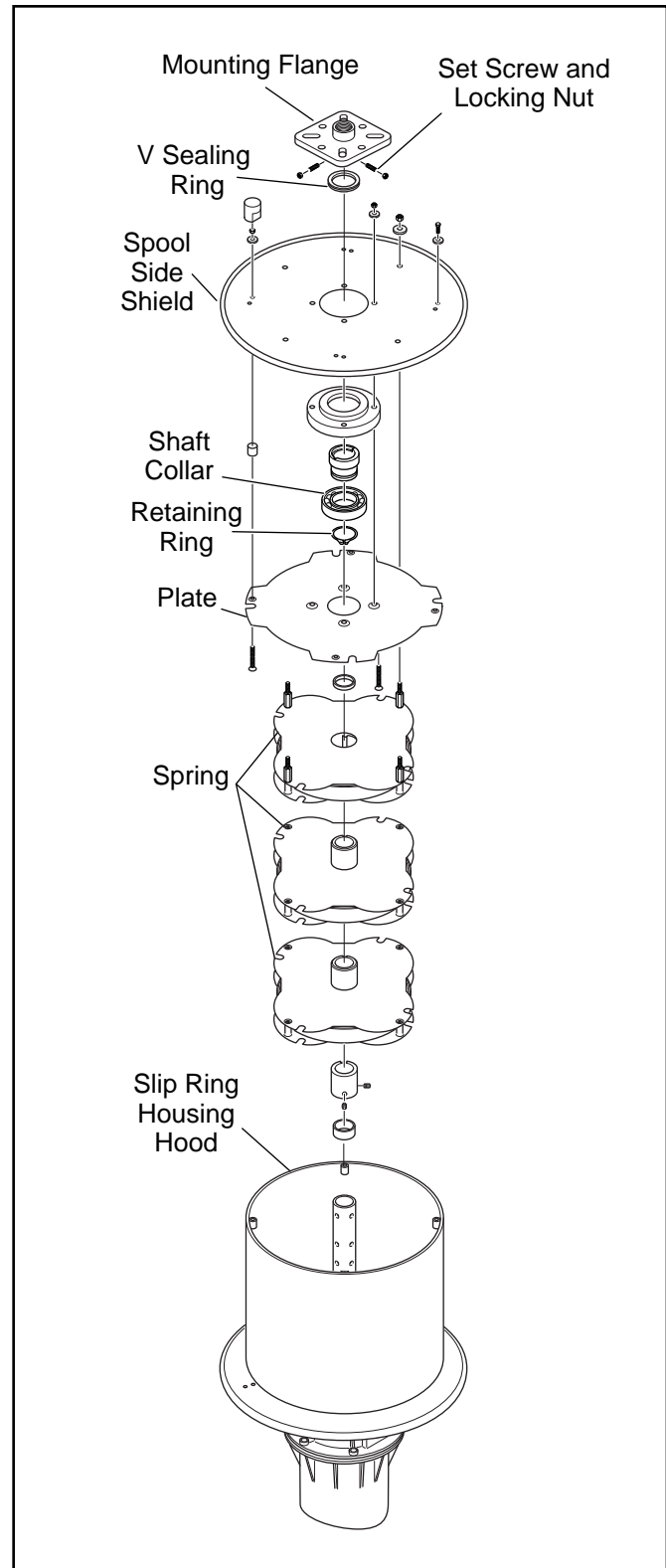

**Figure 5.7** Spring Replacement

7. Before starting disassembly, make sure that there is no tension on the springs. The outer mounting flange should turn freely.
8. Loosen the screws holding the mounting flange and the spool side shield in place. After removing the spool shield, the other components can be pulled off the shaft. The spring removal process can be observed from Figure 5.7.

**WARNING:**

Exercise extreme care when working with cable reel springs. A spring under tension is dangerous and could cause serious injury.

9. Unless a new working cable is being replaced at the same time, it is not necessary to remove the slip ring cover or disconnect the working cable conductors.

**NOTE:**

When installing new springs, pay close attention to the assembly sequence of the plate and springs.

To assemble the cable reel:

1. Follow the sequence shown in Figure 5.7. Press down on the shaft to secure components snugly.
2. Replace springs or other components as needed.

To place cable reel back in service:

1. Install the reel in the crawler and reconnect the crawler power wires and the cable reel sensor wire.
2. Pre-tension the cable reel spring by turning the reel seven times in direction of arrow.
3. Pull cable off reel from underside and route cable through crawler guide rollers.
4. Feed cable through pivot fitting on car and into the car control panel.
5. Make terminal connections inside car control panel.
6. Restore system power.

## 5.7 LITHIUM BATTERIES

Each SLC-500 controller contains a lithium battery that maintains system memory when power is off. Figure 5.8 shows the shape and position of the battery which installs under the front panel of the SLC-500. Both batteries should be replaced annually or sooner if “Battery Good” indicator does not light. Failure to do so will result in loss of PC memory.

To change a battery:

1. Make sure power is on. Changing battery with power off may result in memory loss.
2. Open battery door located on front of PLU.
3. Remove battery from PLU.
4. Insert new battery.
5. Close battery door.

If memory loss does occur due to a dead battery, refer to Troubleshooting, Section 6.3.4.

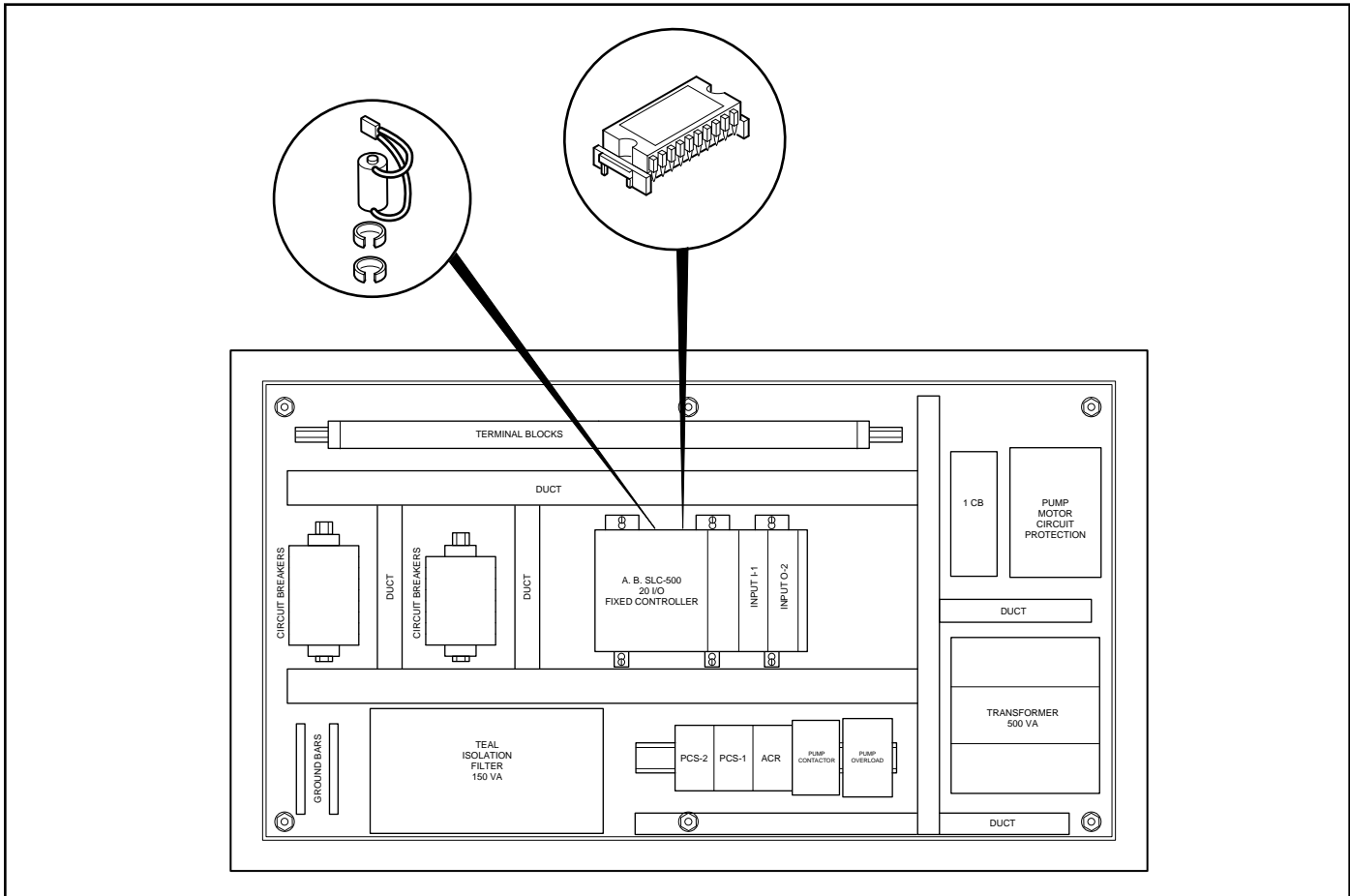

**Figure 5.8** Lithium Battery and EEPROM



**5.8 MAINTENANCE TIME TABLE**

Table 5.3 shows the suggested schedule for preventative maintenance of the LSC-40C. The service intervals shown apply under normal operating conditions. In cases of adverse conditions, such as excessive dust or very high temperatures, maintenance should be performed at more frequent intervals.

<b>Equipment</b>	<b>Scheduled Maintenance</b>
Car safety bars	Daily
Crawler safety bars	
Signal light	
Signal horn	
Sensors	
Safety decals	
Actuators	
Hydraulic fittings	Quarterly
Hydraulic filter	
Hydraulic fluid	
Cable	Semi-Annually
Cable springs	
Lithium batteries	Annually

**Table 5.3** Maintenance Time Table



## **SECTION 6**

# **TROUBLESHOOTING**

Most troubleshooting is handled by the computer messages in the car and crawler diagnostics. Here are some common problems:

- 6.1 Car Diagnostics
- 6.2 Crawler Diagnostics
- 6.3 Other Diagnostic Checks

### **6.1 CAR DIAGNOSTICS**

If an error originates with the car, the Operator Message Center on the Car Program Screen displays an error message and the required operator action. See Section 3.2.8.

### **6.2 CRAWLER DIAGNOSTICS**

If an error originates with the crawler, one or more lamps on the crawler control panel illuminate to identify the error condition. Use the Crawler Fault Diagnostic Charts to determine error and proper action. See Section 3.2.3.

### 6.3 OTHER DIAGNOSTIC CHECKS

- 6.3.1 Battery
- 6.3.2 Fuses
- 6.3.3 Circuit Breakers
- 6.3.4 Memory Loss
- 6.3.5 Hydraulics Failure

#### 6.3.1 Battery

The car and the crawler each have power supplied by a lithium battery. The batteries are located in the power supplies inside the car and crawler control panels. Refer to Maintenance Section 5.7 to replace battery if a low signal activates. See Figures 6.1 and 6.2.

#### 6.3.2 Fuses

A blown fuse may cause the power supply indicator light to illuminate on the controller. Check the two fuses located behind the lithium batteries, in the car and crawler control panels. Replace blown fuses with new fuses. See Figures 6.1 and 6.2.

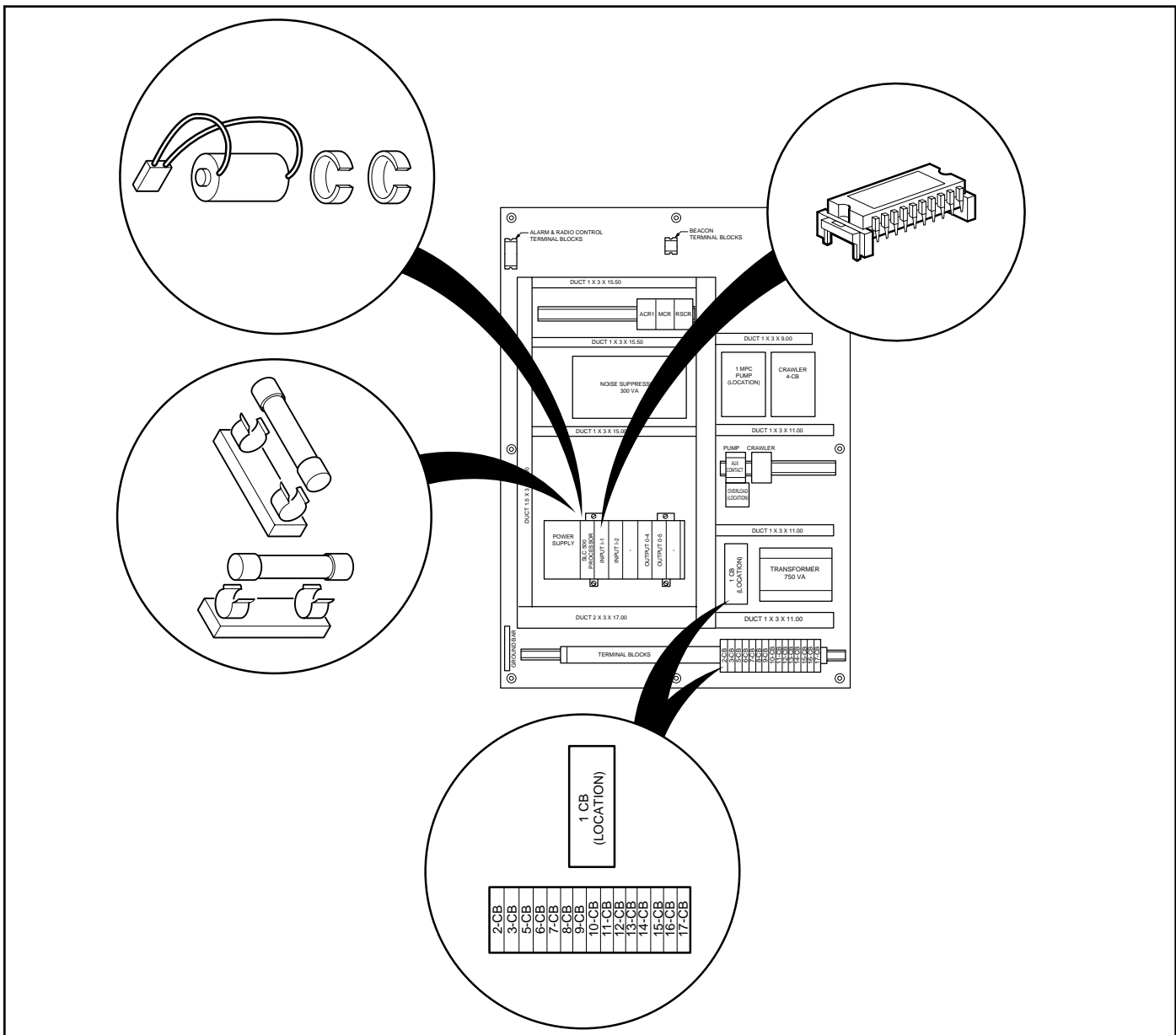
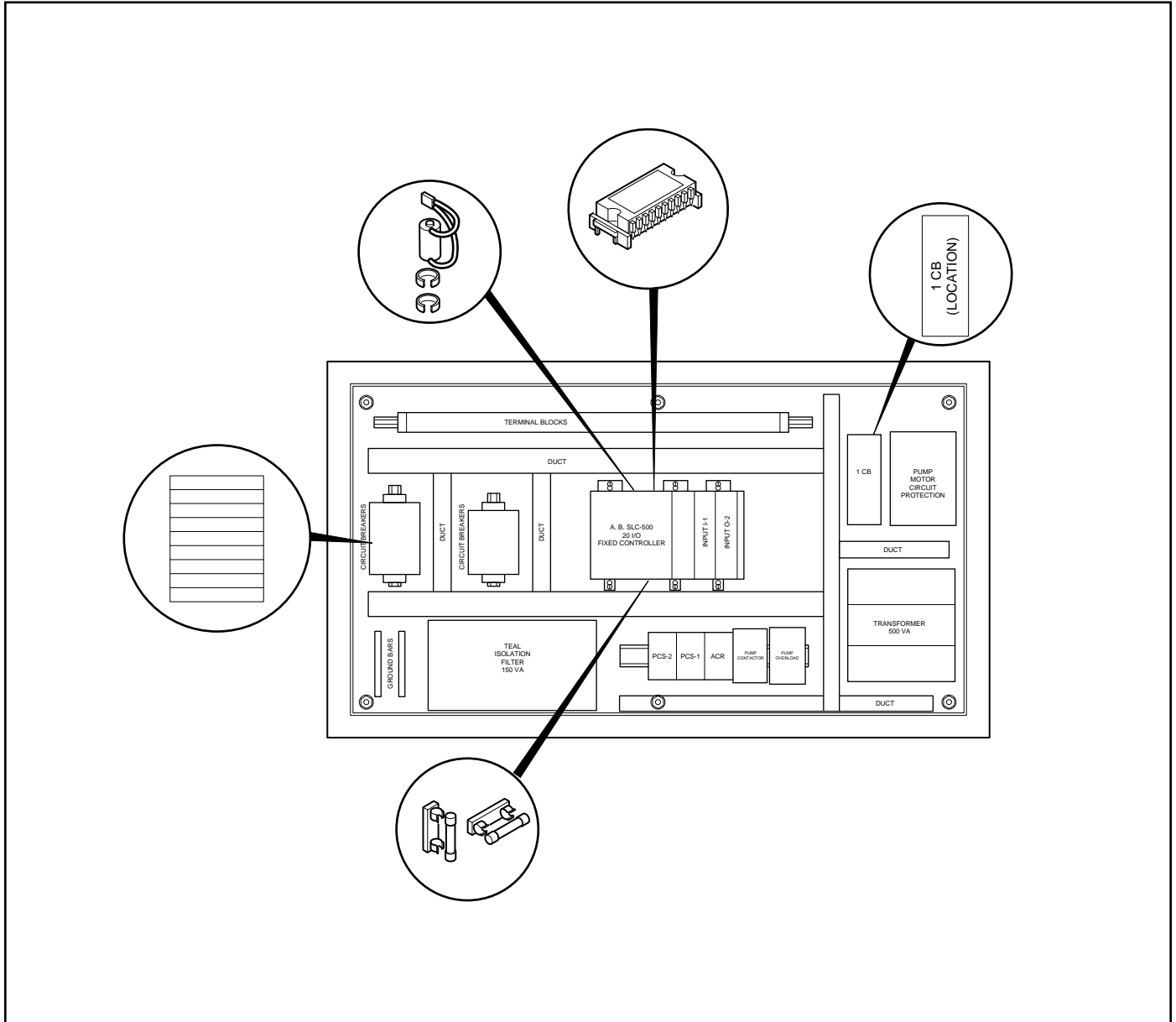

Figure 6.1 Car Battery, Fuses, EEPROM and Circuit Breakers

**6.3.3 Circuit Breakers**

A tripped circuit breaker may result for no apparent reason and from no fault of the machine. Check the circuit breakers, located in the car and crawler control panels, and reset any tripped circuit breakers. See Figures 6.1 and 6.2.

Persistent circuit breaker tripping indicates a problems exists. Correct the problem as required.



**Figure 6.2** Crawler Battery, Fuses, EEPROM and Circuit Breakers

**6.3.4 Memory Loss**

Power to a panel may be lost due to:

- Power surge or drop
- Dead battery

If power is lost a memory loss may result. To restore the memory:

1. Turn the panel power off.
2. Insert EEPROM into the inside of the processor.
3. Restore the power. The SLC-500 will automatically read the EEPROM into its RAM and go into the run mode. The PLU light will illuminate to indicate a successful transfer.
4. Turn the power off.
5. Remove the EEPROM from the unit.

**6.3.5 Hydraulics Failure**

Failure of the hydraulics system can be caused by several problems:

- High temperature
- Clogged filter
- Pump failure
- System leakage

If the hydraulics lock-up, use the external hydraulic valves to move the car or crawler. Figure 6.3 shows the external hydraulics valves:

- Left lift bar
- Right lift bar
- Wheel motors

To use an external hydraulic source, open all valves counterclockwise to allow wheels or lift bar to move freely.

**6.4 TECHNICAL ASSISTANCE**

If these checks do not resolve the problem, please call Besser technical assistance. To best assist the Besser technical staff, be prepared with the following information:

- Sequence of events that caused the shut down or problem
- Part of the system that shuts down or malfunctions
- Identification of the problem
- LSC-40C computer screen report
- Lights flashing on the car or crawler
- Any input/output devices reporting trouble

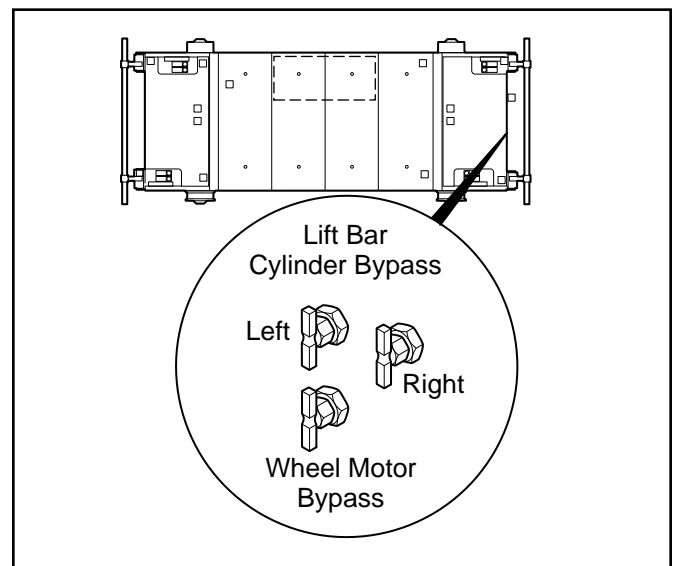

**Figure 6.3** External Hydraulic Valves